

Mini DC - Lasttrennschalter für Photovoltaik

nach IEC 60364-7-712

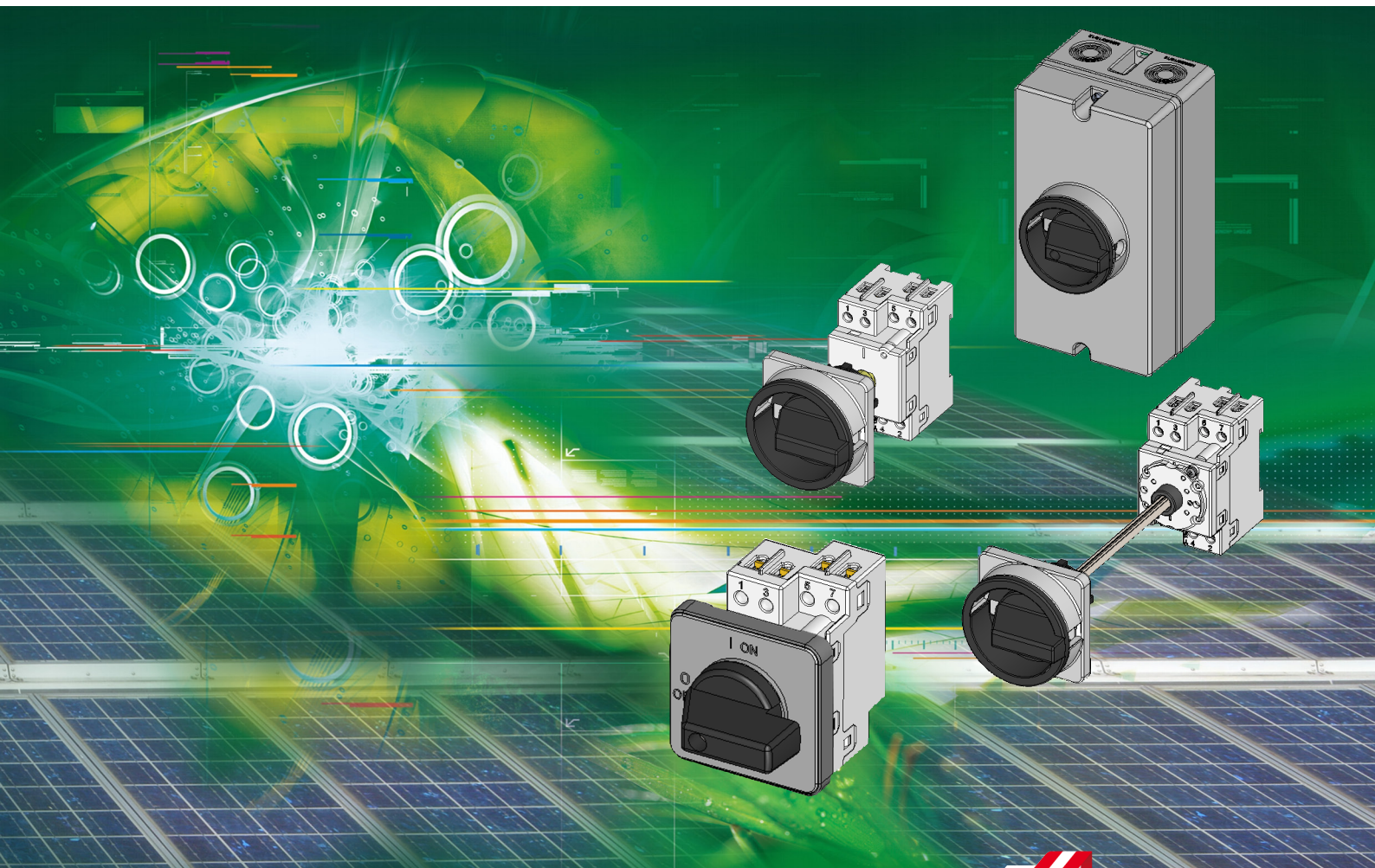

Qualität aus Österreich



D1024D171

**Schütze
Motor-Starter**



Mini-Schütze
Leistungsschütze
Motorschutzrelais
Kondensatorschütze
Motor-Starter
Schütze für Reiheneinbau

 Technische Liste **D677D..**

**Leistungsschal-
ter**



M4-32T... bis 32A
M4-32R... bis 32A
M4-63R... bis 63A
M4-100R... bis 100A

 Technische Liste **D795D..**

Schalter



Ausschalter
Umschalter
Motorschalter
Stufenschalter
Hauptschalter
Reiheneinbauschalter
Schlüsselschalter

 Technische Liste **D371D..**

Hauptschalter



Not-Aus-Hauptschalter
Hauptschalter
Ein-Aus-Schalter
Anbaumodule

 Technische Liste **D656D..**

**Kondensator-
schütze**



Schütze für verdrosselte
und unverdrosselte
Kompensationsanlagen

 Technische Liste **D385D..**

**Motorschutz-
schalter**



MU25A bis max. 32A
Hilfskontakte
Auslöser
Schienensystem
Gehäuse

 Technische Liste **D509D..**

**Befehls- u. Mel-
degeräte**



Drucktasten
Not-Aus-Tasten
Schlüsselschalter
Knebelschalter
Leuchtmelder
Gekapselte Taster-
kombinationen

 Technische Liste **D580D..**

**Reiheneinbau-
Geräte**



Schütze für Reiheneinbau
Zubehör
Sicherheitsschalter
Hauptschalter Not-Aus
Lasttrennschalter
Steuerschalter

 Technische Preisliste **D681D..**

**DC-Schalter u. Schütze
für Photovoltaik**



Not-Aus-Hauptschalter
Hauptschalter
Ein-Aus-Schalter
Schütze für
Gleichstromschaltung

 Technische Liste **D911D..**

**Niederspannungs-
Schaltgeräte**



Schütze
Direktstarter
Motorschutzrelais
Motorschutzschalter
Hauptschalter
Leistungsschalter
Nockenschalter
Befehls- u. Meldegeräte

 Auszugsliste **D651D..**



EIN-AUS Mini DC-Schalter für Fronteinbau (4 Loch)
 Mini DC-Hauptschalter für Fronteinbau (4 Loch)

6
 6



EIN-AUS Mini DC-Schalter für Fronteinbau (2 Loch)
 Mini DC-Hauptschalter für Fronteinbau (2 Loch)

6
 7

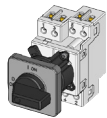

EIN-AUS Mini DC-Schalter für Zentralbefestigung (Ø22,5mm)
 Mini DC-Hauptschalter für Zentralbefestigung (Ø22,5mm)

7
 8

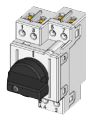

EIN-AUS Mini DC-Schalter für Zentralbefestigung (Ø16mm)
 Mini DC-Hauptschalter für Zentralbefestigung (Ø16mm)

8
 8



EIN-AUS Mini DC-Schalter für Bodenmontage
 Mini DC-Hauptschalter für Bodenmontage

9
 9

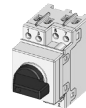

EIN-AUS Mini DC-Schalter für Reiheneinbau
 Mini DC-Hauptschalter für Reiheneinbau

9
 10

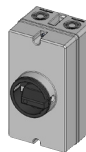

Mini DC-Hauptschalter, isolierstoffgekapselt

10



Technische Daten
 Zulassungen
 Abmessungen

11
 15
 18

Nennwerte

Nennstrom

Typ	I_{th} offen	DC21B(DC-PV1) at U_e
	A	4 Kontakte in Serie A V

LSM16	16	16	1000
LSM25	25	25	1000

Mini DC-Lasttrennschalter

Bauformen

Fronteinbau
Vierlochbefestigung
IP66¹⁾ Type 3R

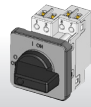

Fronteinbau
Zweilochbefestigung
IP66¹⁾ Type 3R

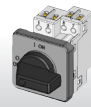

Zentralbefestigung
Ø22,5mm
IP66¹⁾ Type 4X

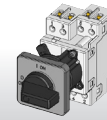

Zentralbefestigung
Ø16mm
IP66¹⁾ Type 4X

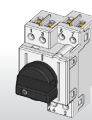

LSM16	16	16	1000	..E. EH4..	..E2. E2H1..	..Z(O). ZH1..	..Z16. Z16H448..
LSM25	25	25	1000	..E. EH4..	..E2. E2H1..	..Z(O). ZH1..	..Z16. Z16H448..

Mini DC-Lasttrennschalter für Photovoltaik

Gemäß IEC 60364-7-712 „Errichten von Photovoltaik-Versorgungssystemen“ ist eine Einrichtung zum Trennen (= Lasttrennschalter) der Photovoltaik-Module vom Wechselrichter verbindlich vorgeschrieben.

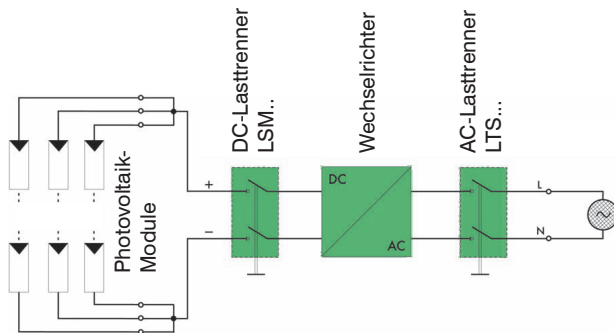

Mini Lasttrennschalter „LSM“ gewährleisten ein zuverlässiges Schalten von bis zu 25A bei 1200V in der Kategorie DC21A und DC21B.

Die Kontakte sind gegen Oxydation (bei geringer Schalthäufigkeit) und somit gegen unzulässige Erwärmung geschützt.

Mini Lasttrennschalter „LSM“ sind mit 2 oder 4 schaltbaren, einzelnen Kontakten ausgestattet. Durch Serien- und Parallelschaltung der Kontakte kann die Schaltleistung entsprechend erhöht werden.

Die hohe Schaltgeschwindigkeit der Kontakte ist unabhängig von der Betätigungsgeschwindigkeit des Handgriffes.

Schaltprogramme

Typ	2-polig	2+2-polig 2 Pole in Serie + 2 Pole parallel	4-polig	4-polig mit Brücken Einspeisung oben Abgang unten	4-polig 2 Brücken oben Einspeisung und Abgang unten	4-polig 2 Brücken unten Einspeisung und Abgang oben
LSM16	.. A2	.. A2+2	.. A4(2 x A2)	.. A4B	.. A4O	.. A4U
LSM25	.. A2	.. A2+2	.. A4(2 x A2)	.. A4B	.. A4O	.. A4U

Kontaktausführung
Schaltbild

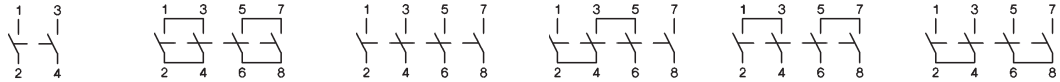

Anwendungsbeispiel

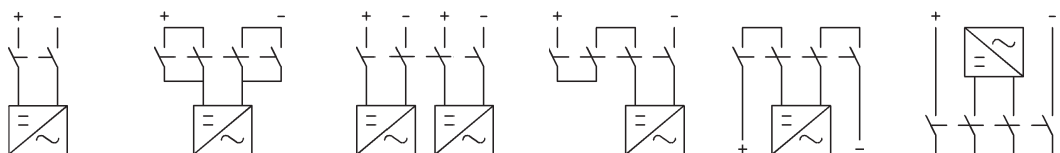

Bestellanleitung

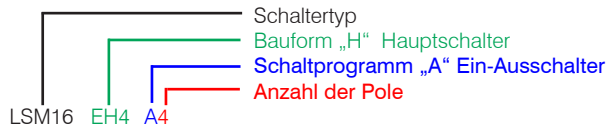

1) Schutzart von vorne im eingebauten Zustand

Mini DC-Lasttrennschalter

Bodenmontage mit Tür-
kupplung, Zentralbefestigung,
Ø22,5mm, IP66¹⁾ Type 4X

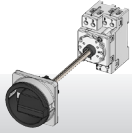

Reiheneinbau
IP40¹⁾
Open Type

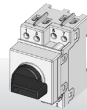

Preßstoffgekapselt
PFL.. IP67¹⁾ Type 4X

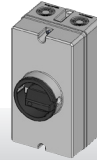

..VZV, VZVH4..

..SMA, SMAH1N..

..PFLH4..

..VZV, VZVH4..

..SMA, SMAH1N..

..PFLH4..

Technische Daten für DC, nach IEC 60947-3, VDE0660

Typ			DC21B (DC-PV1)							DC22B				
			500V	600V	700V	800V	900V	1000V	1200V	1500V	500V	600V	800V	1000V
2 Pole in Serie		LSM16.. LSM25..	16A 25A	16A 25A	16A 25A	16A 19A	16A 17A	10A 11,5A	7A 8,5A	3A 5A	7A 8A	5,5A 6A	2A 2,5A	1A 1,5A
2 Pole in Serie + 2 parallel		LSM16.. LSM25..	29A 45A	29A 36A	22A 27A	17A 19A	16A 17A	10A 12A	7A 9A	3A 5A	-	-	-	-
4 Pole in Serie		LSM16.. LSM25..	16A 25A	16A 25A	16A 25A	16A 25A	16A 25A	16A 25A	16A 25A	16A 25A	16A 25A	16A 25A	11,5A 12A	8A 9A

Isolierter Verbinder LSMV... für Serien- und Parallelschaltung von Kontakten (Klemmen 1-3, 5-7, 2-4, 6-8)

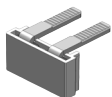

Typ	VPE	Gewicht
LSM16, LSM25	LSMV-B1	100
		6,0 g/Stk.

1) Schutzart von vorne im eingebauten Zustand

EIN-AUS Mini DC-Schalter für Fronteinbau, Vierlochbef., Schild 64, IP66, Type 3R



DC21B / DC-PV1 600V DC 1000V DC		Anzahl Pole in Serie	Anzahl Strings	Typ	VPE Stk.	Gewicht kg/Stk.
16A	10A	2	1	LSM16 E A2	1	0,
25A	11,5A	2	1	LSM25 E A2	1	0,
29A	10A	2	1	LSM16 E A2+2	1	0,
45A	12A	2	1	LSM25 E A2+2	1	0,
16A	10A	2	2	LSM16 E A4	1	0,
25A	11,5A	2	2	LSM25 E A4	1	0,
16A	16A	4	1	LSM16 E A4B	1	0,
25A	25A	4	1	LSM25 E A4B	1	0,
16A	16A	4	1	LSM16 E A4O	1	0,
25A	25A	4	1	LSM25 E A4O	1	0,
16A	16A	4	1	LSM16 E A4U	1	0,
25A	25A	4	1	LSM25 E A4U	1	0,

Mini DC-Hauptschalter für Fronteinbau, Vierlochbef., Schild 64, IP66, Type 3R



16A	10A	2	1	LSM16 EH4 A2	1	0,
25A	11,5A	2	1	LSM25 EH4 A2	1	0,
29A	10A	2	1	LSM16 EH4 A2+2	1	0,
45A	12A	2	1	LSM25 EH4 A2+2	1	0,
16A	10A	2	1	LSM16 EH4 A4	1	0,
25A	11,5A	2	1	LSM25 EH4 A4	1	0,
16A	16A	4	1	LSM16 EH4 A4B	1	0,
25A	25A	4	1	LSM25 EH4 A4B	1	0,
16A	16A	4	1	LSM16 EH4 A4O	1	0,
25A	25A	4	1	LSM25 EH4 A4O	1	0,
16A	16A	4	1	LSM16 EH4 A4U	1	0,
25A	25A	4	1	LSM25 EH4 A4U	1	0,

EIN-AUS Mini DC-Schalter für Fronteinbau, Zweilochbef., Schild 64, IP66, Type 3R



16A	10A	2	1	LSM16 E2 A2	1	0,
25A	11,5A	2	1	LSM25 E2 A2	1	0,
29A	10A	2	1	LSM16 E2 A2+2	1	0,
45A	12A	2	1	LSM25 E2 A2+2	1	0,
16A	10A	2	2	LSM16 E2 A4	1	0,
25A	11,5A	2	2	LSM25 E2 A4	1	0,
16A	16A	4	1	LSM16 E2 A4B	1	0,
25A	25A	4	1	LSM25 E2 A4B	1	0,
16A	16A	4	1	LSM16 E2 A4O	1	0,
25A	25A	4	1	LSM25 E2 A4O	1	0,
16A	16A	4	1	LSM16 E2 A4U	1	0,
25A	25A	4	1	LSM25 E2 A4U	1	0,

Mini DC-Hauptschalter für Fronteinbau, Zweilochbef., Schild 64, IP66, Type 3R



DC21B / DC-PV1		Anzahl Pole in Serie	Anzahl Strings	Typ	VPE Stk.	Gewicht kg/Stk.
600V DC	1000V DC					
16A	10A	2	1	LSM16 E2H1 A2	1	0,
25A	11,5A	2	1	LSM25 E2H1 A2	1	0,
29A	10A	2	1	LSM16 E2H1 A2+2	1	0,
45A	12A	2	1	LSM25 E2H1 A2+2	1	0,
16A	10A	2	2	LSM16 E2H1 A4	1	0,
25A	11,5A	2	2	LSM25 E2H1 A4	1	0,
16A	16A	4	1	LSM16 E2H1 A4B	1	0,
25A	25A	4	1	LSM25 E2H1 A4B	1	0,
16A	16A	4	1	LSM16 E2H1 A4O	1	0,
25A	25A	4	1	LSM25 E2H1 A4O	1	0,
16A	16A	4	1	LSM16 E2H1 A4U	1	0,
25A	25A	4	1	LSM25 E2H1 A4U	1	0,

EIN-AUS Mini DC-Schalter für Zentralbefestigung, Ø22,5mm, Schild 48, IP66, Type 4X

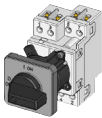

16A	10A	2	1	LSM16 Z A2	1	0,
25A	11,5A	2	1	LSM25 Z A2	1	0,
29A	10A	2	1	LSM16 Z A2+2	1	0,
45A	12A	2	1	LSM25 Z A2+2	1	0,
16A	10A	2	2	LSM16 Z A4	1	0,
25A	11,5A	2	2	LSM25 Z A4	1	0,
16A	16A	4	1	LSM16 Z A4B	1	0,
25A	25A	4	1	LSM25 Z A4B	1	0,
16A	16A	4	1	LSM16 Z A4O	1	0,
25A	25A	4	1	LSM25 Z A4O	1	0,
16A	16A	4	1	LSM16 Z A4U	1	0,
25A	25A	4	1	LSM25 Z A4U	1	0,

EIN-AUS Mini DC-Schalter für Zentralbefestigung, Ø22,5mm, ohne Schild, IP66, Type 4X

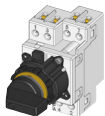

16A	10A	2	1	LSM16 ZO A2	1	0,
25A	11,5A	2	1	LSM25 ZO A2	1	0,
29A	10A	2	1	LSM16 ZO A2+2	1	0,
45A	12A	2	1	LSM25 ZO A2+2	1	0,
16A	10A	2	2	LSM16 ZO A4	1	0,
25A	11,5A	2	2	LSM25 ZO A4	1	0,
16A	16A	4	1	LSM16 ZO A4B	1	0,
25A	25A	4	1	LSM25 ZO A4B	1	0,
16A	16A	4	1	LSM16 ZO A4O	1	0,
25A	25A	4	1	LSM25 ZO A4O	1	0,
16A	16A	4	1	LSM16 ZO A4U	1	0,
25A	25A	4	1	LSM25 ZO A4U	1	0,

Mini DC-Hauptschalter für Zentralbefestigung, Ø22,5mm, Schild 48, IP66, Type 4X

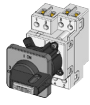

DC21B / DC-PV1		Anzahl Pole in Serie	Anzahl Strings	Typ	VPE Stk.	Gewicht kg/Stk.
600V DC	1000V DC					
16A	10A	2	1	LSM16 ZH1 A2	1	0,
25A	11,5A	2	1	LSM25 ZH1 A2	1	0,
29A	10A	2	1	LSM16 ZH1 A2+2	1	0,
45A	12A	2	1	LSM25 ZH1 A2+2	1	0,
16A	10A	2	2	LSM16 ZH1 A4	1	0,
25A	11,5A	2	2	LSM25 ZH1 A4	1	0,
16A	16A	4	1	LSM16 ZH1 A4B	1	0,
25A	25A	4	1	LSM25 ZH1 A4B	1	0,
16A	16A	4	1	LSM16 ZH1 A4O	1	0,
25A	25A	4	1	LSM25 ZH1 A4O	1	0,
16A	16A	4	1	LSM16 ZH1 A4U	1	0,
25A	25A	4	1	LSM25 ZH1 A4U	1	0,

EIN-AUS Mini DC-Schalter für Zentralbefestigung, Ø16mm, ohne Schild, IP66, Type 4X

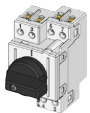

16A	10A	2	1	LSM16 Z16 A2	1	0,
25A	11,5A	2	1	LSM25 Z16 A2	1	0,
29A	10A	2	1	LSM16 Z16 A2+2	1	0,
45A	12A	2	1	LSM25 Z16 A2+2	1	0,
16A	10A	2	2	LSM16 Z16 A4	1	0,
25A	11,5A	2	2	LSM25 Z16 A4	1	0,
16A	16A	4	1	LSM16 Z16 A4B	1	0,
25A	25A	4	1	LSM25 Z16 A4B	1	0,
16A	16A	4	1	LSM16 Z16 A4O	1	0,
25A	25A	4	1	LSM25 Z16 A4O	1	0,
16A	16A	4	1	LSM16 Z16 A4U	1	0,
25A	25A	4	1	LSM25 Z16 A4U	1	0,

Mini DC-Hauptschalter für Zentralbefestigung, Ø16mm, Schild 48, IP66, Type 4X

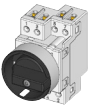

16A	10A	2	1	LSM16 Z16H448 A2	1	0,
25A	11,5A	2	1	LSM25 Z16H448 A2	1	0,
29A	10A	2	1	LSM16 Z16H448 A2+2	1	0,
45A	12A	2	1	LSM25 Z16H448 A2+2	1	0,
16A	10A	2	2	LSM16 Z16H448 A4	1	0,
25A	11,5A	2	2	LSM25 Z16H448 A4	1	0,
16A	16A	4	1	LSM16 Z16H448 A4B	1	0,
25A	25A	4	1	LSM25 Z16H448 A4B	1	0,
16A	16A	4	1	LSM16 Z16H448 A4O	1	0,
25A	25A	4	1	LSM25 Z16H448 A4O	1	0,
16A	16A	4	1	LSM16 Z16H448 A4U	1	0,
25A	25A	4	1	LSM25 Z16H448 A4U	1	0,

EIN-AUS Mini DC-Schalter für Bodenmontage, Türkuppl. f. Zentralbef., Schild 64, IP66, Type 4X

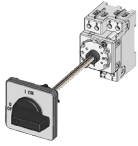

DC21B / DC-PV1 600V DC 1000V DC		Anzahl Pole in Serie	Anzahl Strings	Typ	VPE Stk.	Gewicht kg/Stk.
16A	10A	2	1	LSM16 VZV A2	1	0,
25A	11,5A	2	1	LSM25 VZV A2	1	0,
29A	10A	2	1	LSM16 VZV A2+2	1	0,
45A	12A	2	1	LSM25 VZV A2+2	1	0,
16A	10A	2	2	LSM16 VZV A4	1	0,
25A	11,5A	2	2	LSM25 VZV A4	1	0,
16A	16A	2	1	LSM16 VZV A4B	1	0,
25A	25A	2	1	LSM25 VZV A4B	1	0,
16A	16A	2	1	LSM16 VZV A4O	1	0,
25A	25A	2	1	LSM25 VZV A4O	1	0,
16A	16A	2	1	LSM16 VZV A4U	1	0,
25A	25A	2	1	LSM25 VZV A4U	1	0,

Mini DC-Hauptschalter für Bodenmontage, Türkuppl. f. Zentralbef., Schild 64, IP66, Type 4X



16A	10A	2	1	LSM16 VZVH4 A2	1	0,
25A	11,5A	2	1	LSM25 VZVH4 A2	1	0,
29A	10A	2	1	LSM16 VZVH4 A2+2	1	0,
45A	12A	2	1	LSM25 VZVH4 A2+2	1	0,
16A	10A	2	2	LSM16 VZVH4 A4	1	0,
25A	11,5A	2	2	LSM25 VZVH4 A4	1	0,
16A	16A	4	1	LSM16 VZVH4 A4B	1	0,
25A	25A	4	1	LSM25 VZVH4 A4B	1	0,
16A	16A	4	1	LSM16 VZVH4 A4O	1	0,
25A	25A	4	1	LSM25 VZVH4 A4O	1	0,
16A	16A	4	1	LSM16 VZVH4 A4U	1	0,
25A	25A	4	1	LSM25 VZVH4 A4U	1	0,

EIN-AUS Mini DC-Schalter für Reiheneinbau, IP40, Open Type

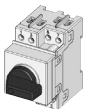

16A	10A	2	1	LSM16 SMA A2	1	0,
25A	11,5A	2	1	LSM25 SMA A2	1	0,
29A	10A	2	1	LSM16 SMA A2+2	1	0,
45A	12A	2	1	LSM25 SMA A2+2	1	0,
16A	10A	2	2	LSM16 SMA A4	1	0,
25A	11,5A	2	2	LSM25 SMA A4	1	0,
16A	16A	4	1	LSM16 SMA A4B	1	0,
25A	25A	4	1	LSM25 SMA A4B	1	0,
16A	16A	4	1	LSM16 SMA A4O	1	0,
25A	25A	4	1	LSM25 SMA A4O	1	0,
16A	16A	4	1	LSM16 SMA A4U	1	0,
25A	25A	4	1	LSM25 SMA A4U	1	0,

Mini DC-Hauptschalter für Reiheneinbau, IP40, Open Type

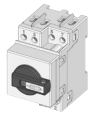

DC21B / DC-PV1 600V DC / 1000V DC		Anzahl Pole in Serie	Anzahl Strings	Typ	VPE Stk.	Gewicht kg/Stk.
16A	10A	2	1	LSM16 SMAH1N A2	1	0,
25A	11,5A	2	1	LSM25 SMAH1N A2	1	0,
29A	10A	2	1	LSM16 SMAH1N A2+2	1	0,
45A	12A	2	1	LSM25 SMAH1N A2+2	1	0,
16A	10A	2	2	LSM16 SMAH1N A4	1	0,
25A	11,5A	2	2	LSM25 SMAH1N A4	1	0,
16A	16A	4	1	LSM16 SMAH1N A4B	1	0,
25A	25A	4	1	LSM25 SMAH1N A4B	1	0,
16A	16A	4	1	LSM16 SMAH1N A4O	1	0,
25A	25A	4	1	LSM25 SMAH1N A4O	1	0,
16A	16A	4	1	LSM16 SMAH1N A4U	1	0,
25A	25A	4	1	LSM25 SMAH1N A4U	1	0,

Mini DC-Hauptschalter, im Kunststoffgehäuse, IP67, Type 4X

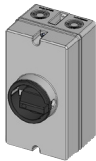



16A	10A	2	1	LSM16 PFLH4 A2	1	0,
25A	11,5A	2	1	LSM25 PFLH4 A2	1	0,
29A	10A	2	1	LSM16 PFLH4 A2+2	1	0,
45A	12A	2	1	LSM25 PFLH4 A2+2	1	0,
16A	10A	2	2	LSM16 PFLH4 A4	1	0,
25A	11,5A	2	2	LSM25 PFLH4 A4	1	0,
16A	16A	4	1	LSM16 PFLH4 A4B	1	0,
25A	25A	4	1	LSM25 PFLH4 A4B	1	0,
16A	16A	4	1	LSM16 PFLH4 A4O	1	0,
25A	25A	4	1	LSM25 PFLH4 A4O	1	0,
16A	16A	4	1	LSM16 PFLH4 A4U	1	0,
25A	25A	4	1	LSM25 PFLH4 A4U	1	0,

Technische Daten

Stromart	Gebrauchskategorie		Typische Anwendungsfälle	Prüfungsbedingungen für Elektrische Lebensdauer (Normale Beanspruchung)						Prüfungsbedingungen für Ein- und Ausschaltvermögen (Beanspruchung im Störfall)					
				Einschalten			Ausschalten			Einschalten			Ausschalten		
				I/le	U/Ue	L/R	Ic/Ie	Ur/Ue	L/R	I/le	U/Ue	L/R	Ic/Ie	Ur/Ue	L/R
Gleich-Strom	DC21A häufige Betätigung	DC21B gelegentl. Betätigung	Schalten von ohmscher Last einschließlich geringer Überlast.	1	1	1ms	1	1	1ms	1,5	1,05	1ms	1,5	1,05	1ms
	DC22A häufige Betätigung	DC22B gelegentl. Betätigung	Schalten von gemischter ohmscher und induktiver Last einschließl. geringer Überlast.	1	1	2ms	1	1	2ms	4	1,05	2,5ms	4	1,05	2,5ms
	DC-PV1		Schalten eines einzelnen PV String(s) ohne Rück- und Überströme.	1	1	1ms	1	1	1ms	1,5	1,05	1ms	1,5	1,05	1ms
	DC-PV2		Schalten von mehreren PV Strings mit Rück- und Überströmen.	1	1	1ms	1	1	1ms	4	1,05	1ms	4	1,05	1ms

Daten nach IEC 60947-3, VDE 0660, GB14048.3 (CCC China)

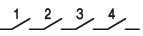
Hauptkontakte		Typ	LSM16	LSM25	
Thermischer Bemessungsbetriebsstrom I_{th}		A	16	25	
Bemessungsisolationsspannung U_i ¹⁾		V	1000	1000	
Bemessungsisolationsspannung U_i ²⁾		V	1500	1500	
Kontaktabstand (pro Pol)		mm	8	8	
Bemessungsbetriebsstrom I_e					
DC21A	1 Pol	300V A	16	23	
		400V A	12	14	
		A1	500V A	9	11
			600V A	6	8
			700V A	4,5	6
			800V A	3	4
			900V A	2,5	3
		1000V A	1,5	2	
	2 Pole in Serie A2	500V A	16	25	
		600V A	16	25	
		700V A	16	23	
		800V A	16	20	
		900V A	13	16	
		1000V A	9	11	
		1200V A	6	8	
		1500V A	3	4	
	2 Pole in Serie + 2 Pole parallel A2 + 2	500V A	29	45	
		600V A	29	45	
700V A		16	23		
800V A		16	20		
900V A		13	16		
	1000V A	9	11		
	1200V A	6	8		
	1500V A	3	4		
4 Pole in Serie A4	500V A	16	25		
	600V A	16	25		
	700V A	16	25		
	800V A	16	25		
	900V A	16	25		
	1000V A	16	25		
	1200V A	16	25		
	1500V A	16	20		
	1200V A	16	25		
	1500V A	16	20		
Bemessungsbetriebsstrom I_e					
AC21B	A2, A4	U_e max. 440V	A	16	25
	A2 + 2	U_e max. 440V	A	29	45



1) Gilt für: Überspannungskategorie I bis III, Verschmutzungsgrad 3 (Norm-Industrie): $U_{imp} = 8kV$.

2) Gilt für: Überspannungskategorie I bis III, Verschmutzungsgrad 2 (min. IP55): $U_{imp} = 8kV$.

3) Gilt für DC21B

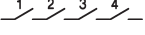

Technische Daten

Daten nach IEC 60947-3, VDE 0660

Hauptkontakte		Typ	LSM16	LSM25	
Bemessungsbetriebsstrom I_e DC-PV1	1 Pol	300V	A	16	23
		400V	A	14	22
	A1 	500V	A	10	17
		600V	A	7	12
		700V	A	5	6
		800V	A	3	4
		900V	A	3	3
		1000V	A	2	2
	2 Pole in Serie A2 	500V	A	16	25
		600V	A	16	25
		700V	A	16	25
		800V	A	16	19
		900V	A	16	17
		1000V	A	10	11,5
		1100V	A	8	10
		1200V	A	7	8,5
		1300V	A	6	7
		1400V	A	5	6
1500V		A	3	5	
2 Pole in Serie + 2 Pole parallel A2+2 		500V	A	29	45
	600V	A	29	36	
	700V	A	22	27	
	800V	A	17	19	
	900V	A	16	17	
	1000V	A	10	11,5	
	1100V	A	8	10	
	1200V	A	7	8,5	
	1300V	A	6	7	
	1400V	A	5	6	
	1500V	A	3	5	
	4 Pole in Serie A4 	500V	A	16	25
600V		A	16	25	
700V		A	16	25	
800V		A	16	25	
900V		A	16	25	
1000V		A	16	25	
1100V		A	16	25	
1200V		A	16	25	
1300V		A	16	25	
1400V		A	16	25	
1500V		A	16	25	

Technische Daten

Daten nach IEC 60947-3, VDE 0660

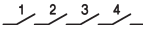

Hauptkontakte		Typ	LSM16	LSM25	
Bemessungsbetriebsstrom I_e DC-PV2	1 Pol	300V	A	16	23
		400V	A	15	18
	A1 	500V	A	10	12
		600V	A	5	6
		700V	A	1,5	2
		800V	A	1,5	2
		900V	A	1	1,5
		1000V	A	1	1,5
	2 Pole in Serie A2 	500V	A	16	25
		600V	A	14	21
		700V	A	13	19
		800V	A	12	15
		900V	A	8	10
		1000V	A	4	5
		1100V	A	3	4
1200V		A	2	3	
1300V		A	1,5	2	
1400V		A	1	2	
1500V		A	1	1,5	
2 Pole in Serie + 2 Pole parallel A2+2 	500V	A	25	39	
	600V	A	20	32	
	700V	A	13	19	
	800V	A	12	15	
	900V	A	8	10	
	1000V	A	4	5	
	1100V	A	3	4	
	1200V	A	2	3	
	1300V	A	1,5	2	
	1400V	A	1	2	
	1500V	A	1	1,5	
4 Pole in Serie A4 	500V	A	16	25	
	600V	A	16	25	
	700V	A	16	25	
	800V	A	16	25	
	900V	A	16	25	
	1000V	A	16	25	
	1100V	A	16	25	
	1200V	A	13,5	21	
	1300V	A	12	19	
	1400V	A	10,5	16	
	1500V	A	9	14	



Technische Daten

Daten nach IEC 60947-3, VDE 0660

Hauptkontakte		Typ	LSM16	LSM25
Bemessungsbetriebsstrom I_e DC22B	1 Pol	A	1	1,25
	A1	A	0,5	0,75
	1	A	0,3	0,4
	1000V	A	0,15	0,2
	1200V	A	-	-
	1500V	A	-	-
	2 Pole in Serie	A	7	8
	A2	A	5,5	6
	1 2	A	2	2,5
	1000V	A	1	1,5
	1200V	A	-	-
	1500V	A	-	-
	4 Pole in Serie	A	16	25
	A4	A	16	25
	1 2 3 4	A	11,5	12
1000V	A	8	9	
1200V	A	-	-	
1500V	A	-	-	
Bedingter Bemessungskurzschlußstrom	kA _{eff}	5	5	
Max. Vorsicherung	gL (gG)	40	63	
Mechanische Lebensdauer	x10 ³	10	10	
Bemessungskurzzeit-	lcw	A	800	900
stromfestigkeit (1s)	A2, A4	A	1300	1500
Bemessungskurzschluß-	lcm	A	800	900
einschaltvermögen	A2, A4	A	1300	1500
Anschlußquerschnitte (inkl. Verbinder LSMV-B1)				
ein- oder mehrdrähtig	mm ²	1,5 - 10	4 - 10	
feindrähtig	mm ²	1,5 - 6	4 - 10	
feindrähtig (+ Aderendhülse)	mm ²	1,5 - 6	4 - 10	
Klemmschraube		M3,5 Pz1	M3,5 Pz1	
Anzugsdrehmoment	Nm	1,4	1,4	
2 Leiter pro Klemme ohne Verbinder LSMV-B1				
ein- oder mehrdrähtig	mm ²	10+(1,5-2,5) / 6+(1,5-6) / 4+(1,5-4)		
feindrähtig	mm ²	(0,5-6)+(0,5-6)		
feindrähtig	AWG	6+(20-14) / 8+(20-12) / 10+(20-10) 12+(20-12)		
eindrähtig	AWG	10+(16-10) / 12+(16-12) 14+(16-14)		
Zulässige Umgebungstemperatur				
Betrieb	offen	°C	-40 to +65	
	gekapselt	°C	-40 to +45	
Lagerung		°C	-50 to +90	
Verlustleistung pro Schalter bei I _e max.				
A2	(A)/	W	(16)/ 1 (25)/ 2,3	
A4	(A)/	W	(16)/ 2 (25)/ 4,6	
A2+2	(A)/	W	(29)/ 1,5 (45)/ 3,7	
Kontaktwiderstand pro Pol		mΩ	1,75 1,75	



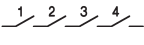

Technische Daten

Daten nach to UL5081  File E359344, Category no.: NMSJ, und UL508  File E332938, Category no.: NRNT2, NRNT8

Typ			LSM16	LSM25	
Ampere-Rating "General use"  1 Pol	DC				
	350V	A	4	5	
	500V	A	4	5	
	600V	A	4	5	
	700V	A	-	-	
	800V	A	-	-	
	900V	A	-	-	
 2 Pole in Serie A2	1000V	A	-	-	
	350V	A	16	25	
	500V	A	16	25	
	600V	A	16	25	
	700V	A	-	-	
	800V	A	-	-	
	900V	A	-	-	
 2 Pole in Serie + 2 Pole parallel A2+2	1000V	A	-	-	
	350V	A	29	45	
	400V	A	-	-	
	500V	A	29	38	
	600V	A	21	27	
	700V	A	-	-	
	800V	A	-	-	
 4 Pole in Serie A4	900V	A	-	-	
	1000V	A	-	-	
	350V	A	16	25	
	500V	A	16	25	
	600V	A	16	25	
	700V	A	-	-	
	800V	A	-	-	
Fuse size (RK5)Industrial Control Switch 5kA / 600V		A	40	60	
	Anschlußquerschnitte (inkl. Verbinder LSMV-B1)				
	ein- oder mehrdrähtig	AWG	16 - 10	16 - 10	
	feindrähtig	AWG	20 - 6	20 - 6	
	feindrähtig (+ Aderendhülse)	AWG	20 - 6	20 - 6	
Klemmschraube		M3,5 Pz1	M3,5 Pz1		
Anzugsdrehmoment	lb.inch	12,4	12,4		
Schutzart der Anschlußklemmen ¹⁾			IP20	IP20	

1) Schutzart der Anschlußklemmen mit angeschlossenem, isoliertem Leiter.

Approbationen

Land	USA, UL5081	US, Canada UL508	Europa	China CCC	CB- Zertifikate	EAC
						
Typ						
LSM16	o	o	/	x	x	o
LSM25	o	o	/	x	x	o

o In Normalausführung approbiert / Approbationen nicht erforderlich CE x zur Approbation eingereicht - keine Approbationen vorgesehen

Technische Daten

Maximal zulässiger Strom, abhängig von Umgebungstemperatur und Anschlußquerschnitten

Schalter offen LSM16..., 2 Kontakte in Serie (A2)

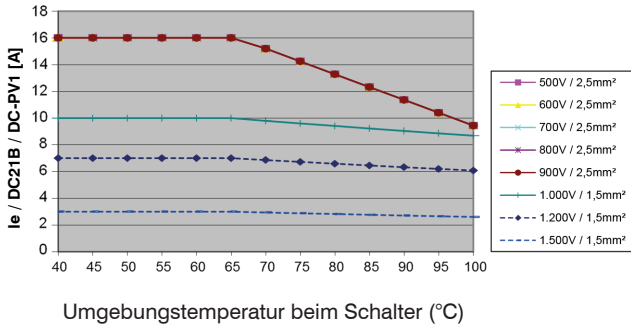

Schalter offen LSM16 ..., 2 Kontakte in Serie + 2 parallel (A2+2)

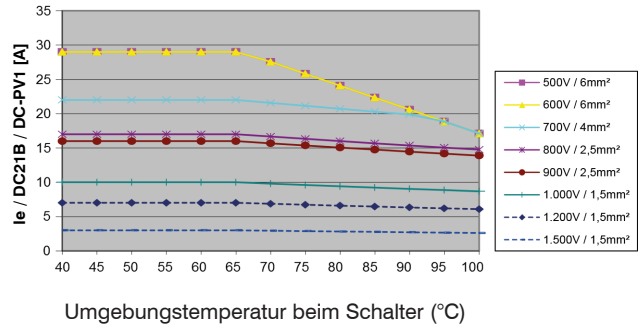

Schalter offen LSM16..., 4 Kontakte in Serie (A4x)

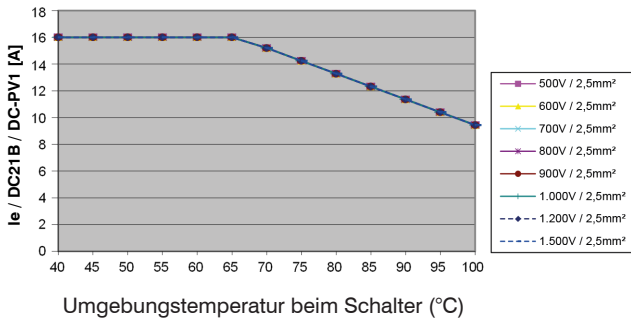

Schalter gekapselt LSM16 PFL..., 2 Kontakte in Serie (A2)

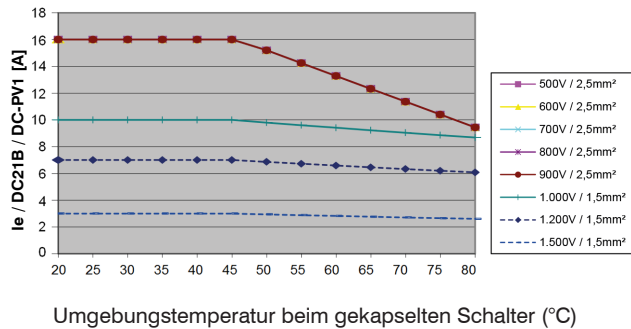

Schalter gekapselt LSM16 PFL..., 2 Kontakte in Serie + 2 parallel (A2+2)

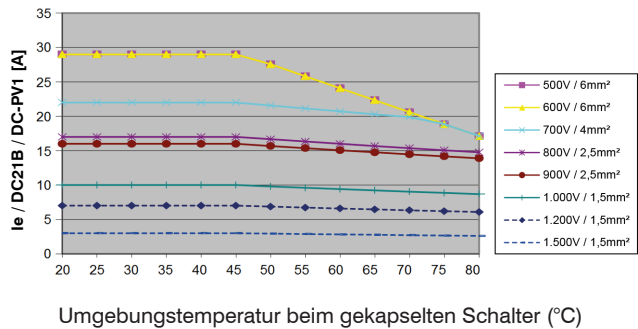

Schalter gekapselt LSM16 PFL..., 4 Kontakte in Serie (A4x)

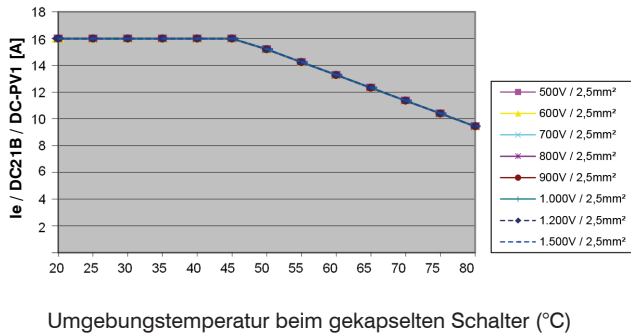

Technische Daten

Maximal zulässiger Strom, abhängig von Umgebungstemperatur und Anschlußquerschnitten

Schalter offen LSM25..., 2 Kontakte in Serie (A2)

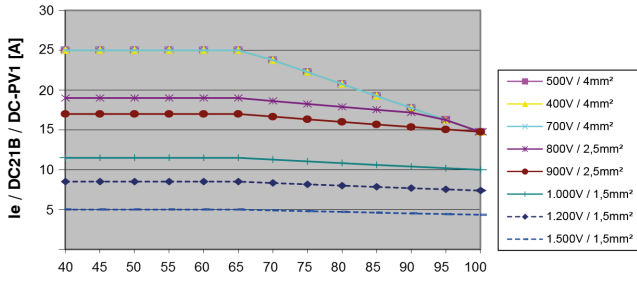

Umgebungstemperatur beim Schalter (°C)

Schalter offen LSM25 ..., 2 Kontakte in Serie + 2 parallel (A2+2)

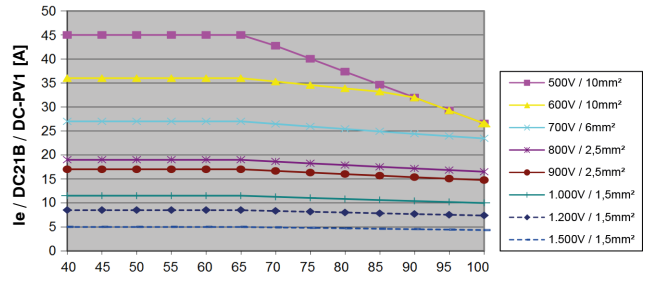

Umgebungstemperatur beim Schalter (°C)

Schalter offen LSM25..., 4 Kontakte in Serie (A4x)

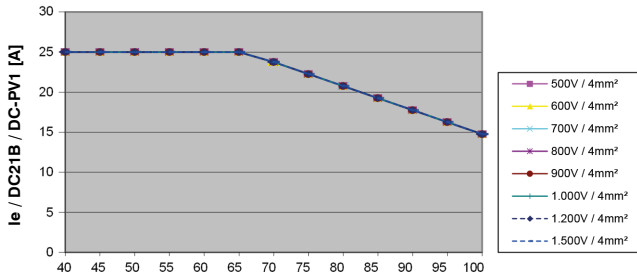

Umgebungstemperatur beim Schalter (°C)

Schalter gekapselt LSM25 PFL..., 2 Kontakte in Serie (A2)

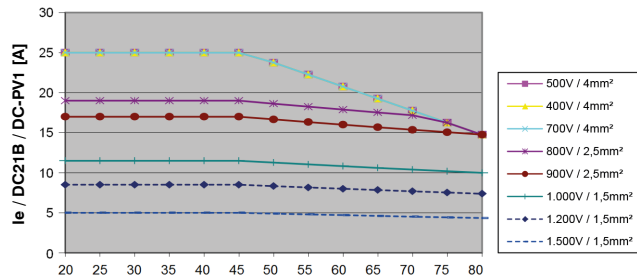

Umgebungstemperatur beim gekapselten Schalter (°C)

Schalter gekapselt LSM25 PFL..., 2 Kontakte in Serie + 2 parallel (A2+2)

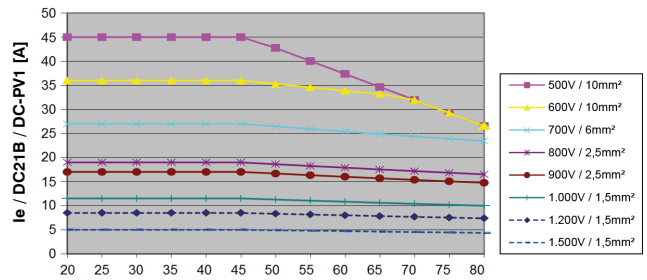

Umgebungstemperatur beim gekapselten Schalter (°C)

Schalter gekapselt LSM25 PFL..., 4 Kontakte in Serie (A4x)

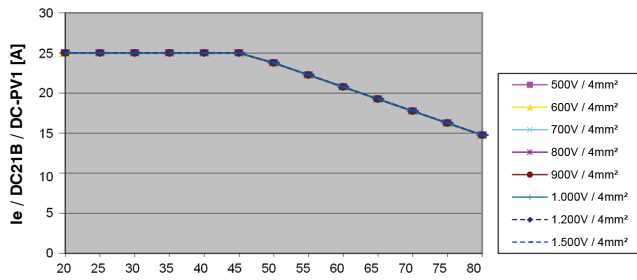

Umgebungstemperatur beim gekapselten Schalter (°C)

Abmessungen:

**LSM16 E..., LSM25 E...,
..A2**

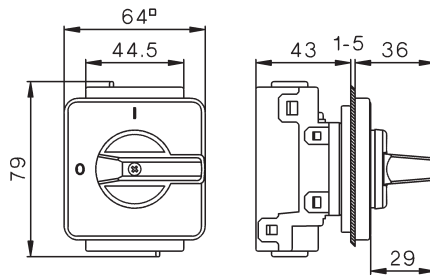

Bohrplan

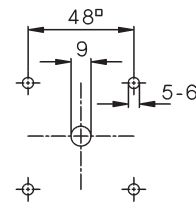

**LSM16 E..., LSM25 E...,
..A2+2, ..A4**

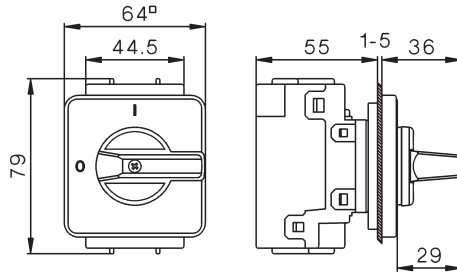

Bohrplan

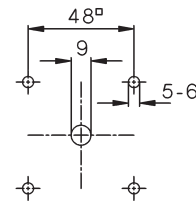

**LSM16 EH4..., LSM25 EH4...,
..A2**

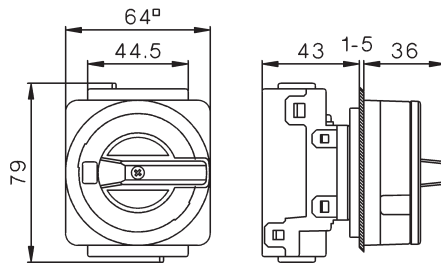

Bohrplan

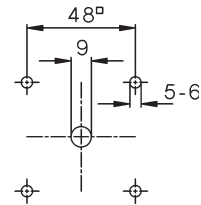

**LSM16 EH4..., LSM25 EH4...,
..A2+2, ..A4**

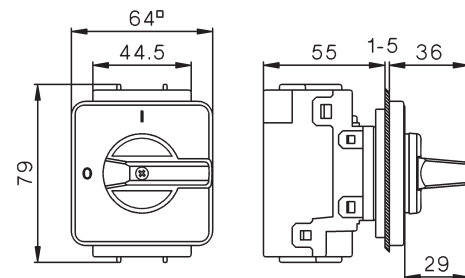

Bohrplan

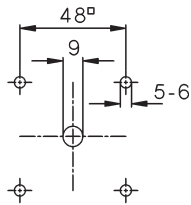

**LSM16 E2..., LSM25 E2...,
..A2**

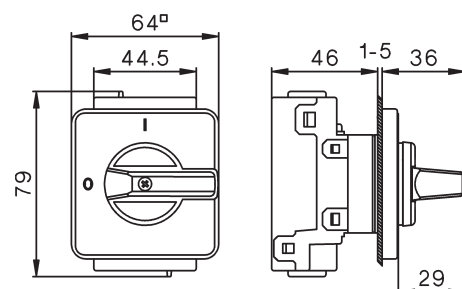

Bohrplan

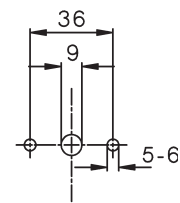

**LSM16 E2..., LSM25 E2...,
..A2+2, ..A4**

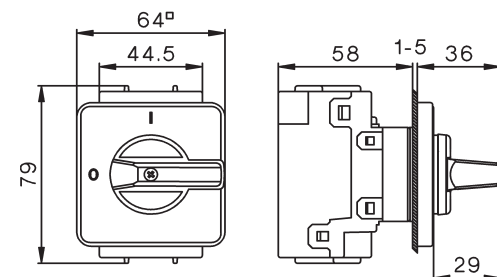

Bohrplan

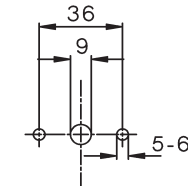

Abmessungen:

**LSM16 E2H1..., LSM25 E2H1...,
..A2**

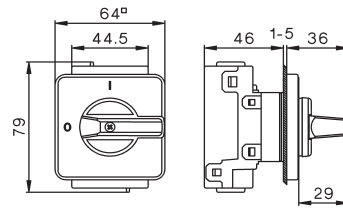

Bohrplan

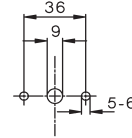

**LSM16 E2H1..., LSM25 E2H1...,
..A2+2, ..A4**

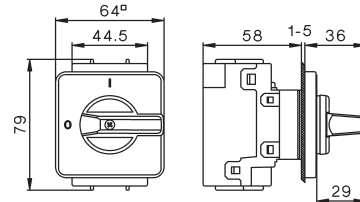

Bohrplan

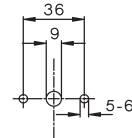

**LSM16 Z..., LSM25 Z...,
..A2**

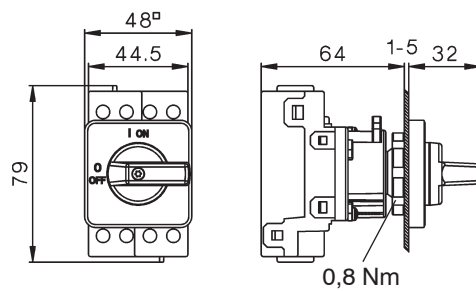

Bohrplan

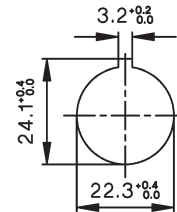

**LSM16 Z..., LSM25 Z...,
..A2+2, ..A4**

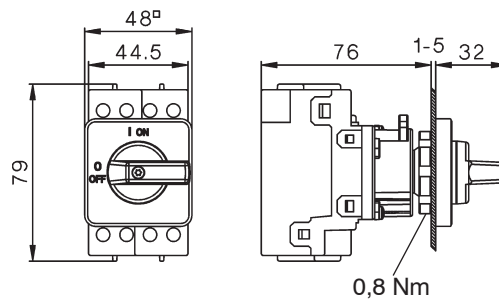

Bohrplan

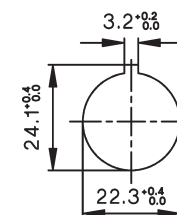

**LSM16 ZO..., LSM25 ZO...,
..A2**

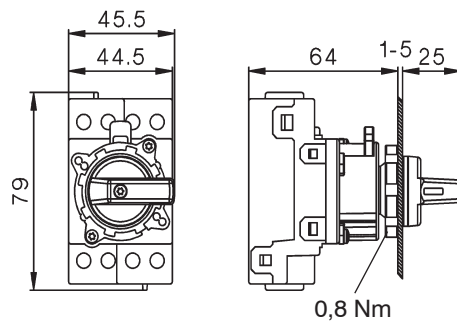

Bohrplan

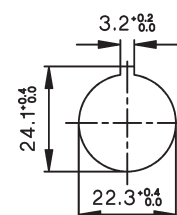

**LSM16 ZO..., LSM25 ZO...,
..A2+2, ..A4**

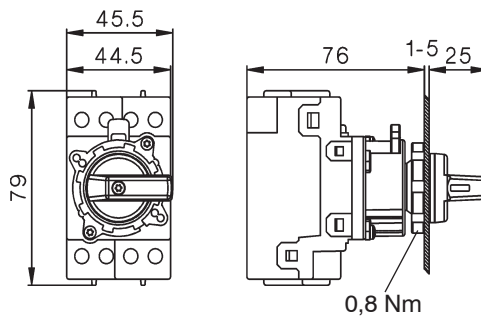

Bohrplan

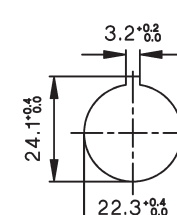

Abmessungen:

LSM16 ZH1..., LSM25 ZH1...,
..A2

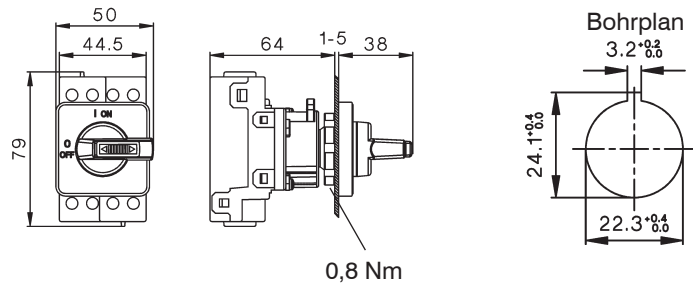

LSM16 ZH1..., LSM25 ZH1...,
..A2+2, ..A4

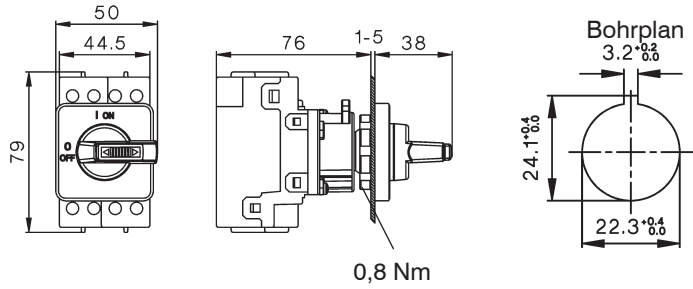

LSM16 Z16..., LSM25 Z16...,
..A2

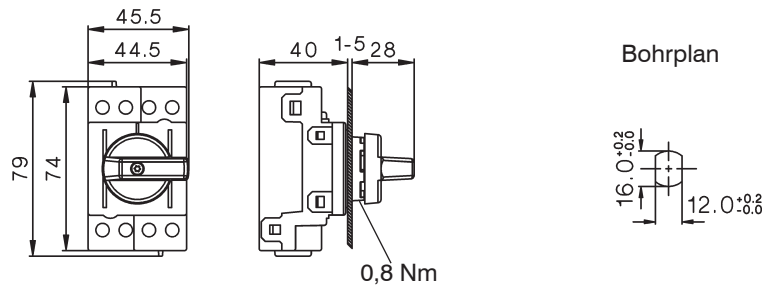

LSM16 Z16..., LSM25 Z16...,
..A2+2, ..A4

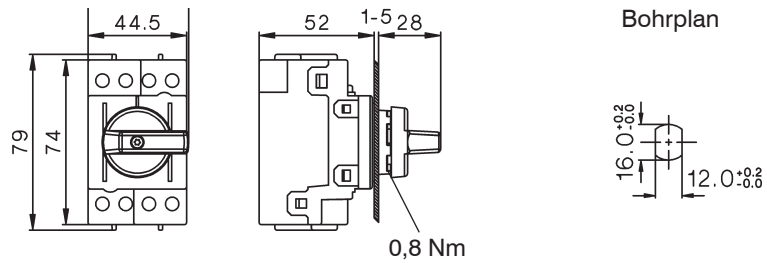

LSM16 ZH448..., LSM25 Z16H448...,
..A2

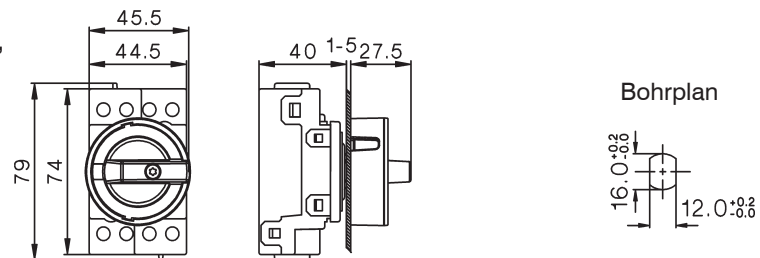

LSM16 ZH448..., LSM25 ZH448...,
..A2+2, ..A4

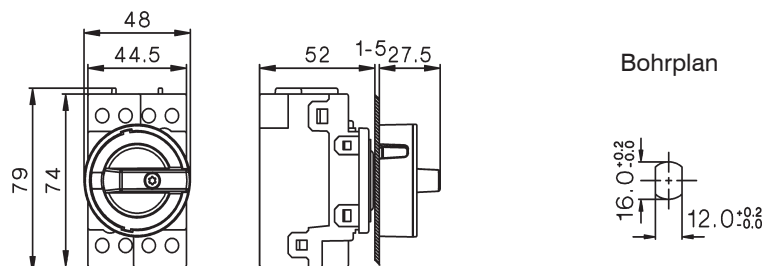

**LSM16 VZV..., LSM25 VZV...,
..A2**

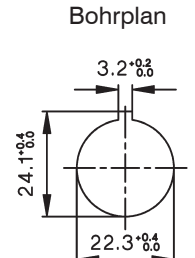
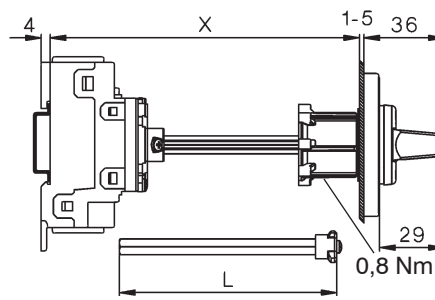
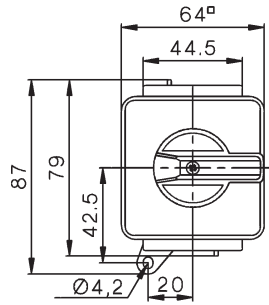

$X_{max} = 182, L = 155,5$
($X_{min} = \dots$)
 $L = X - 26,5 \pm 3$

**LSM16 VZV..., LSM25 VZV...,
..A2+2, ..A4**

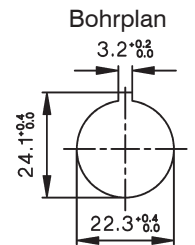
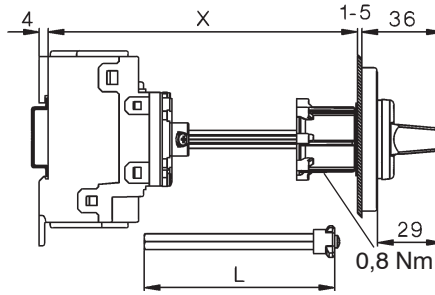
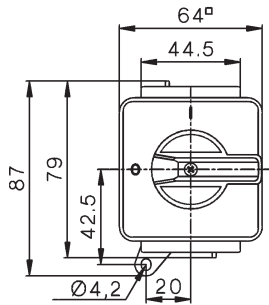

$X_{max} = 194, L = 155,5$
($X_{min} = \dots$)
 $L = X - 38,5 \pm 3$

**LSM16 VZVH4..., LSM25 VZVH4...,
..A2**

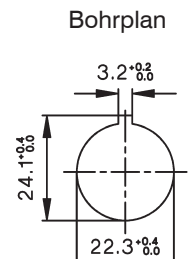
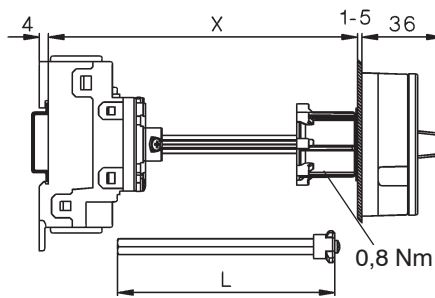
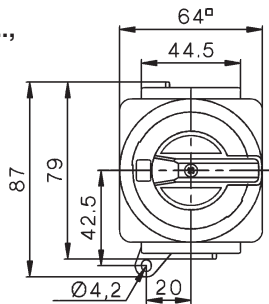

$X_{max} = 182, L = 155,5$
($X_{min} = \dots$)
 $L = X - 26,5 \pm 3$

**LSM16 VZVH4..., LSM25 VZVH4...,
..A2+2, ..A4**

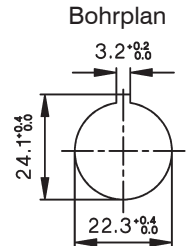
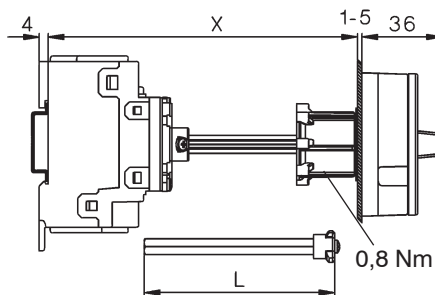
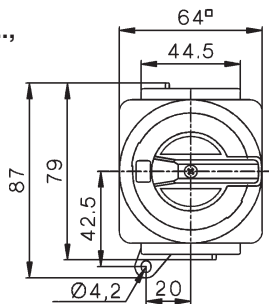

$X_{max} = 194, L = 155,5$
($X_{min} = \dots$)
 $L = X - 38,5 \pm 3$

Abmessungen:

LSM16 SMA..., LSM25 SMA...,
..A2

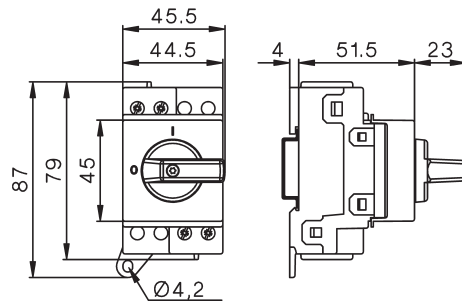

LSM16 SMA..., LSM25 SMA...,
..A2+2, ..A4

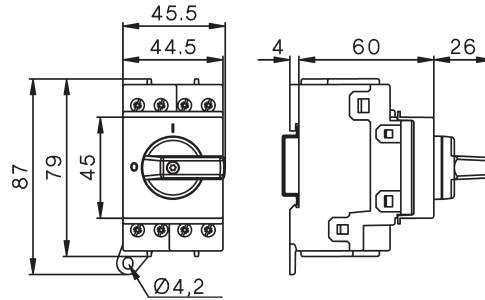

LSM16 SMAH1N..., LSM25 SMAH1N...,
..A2

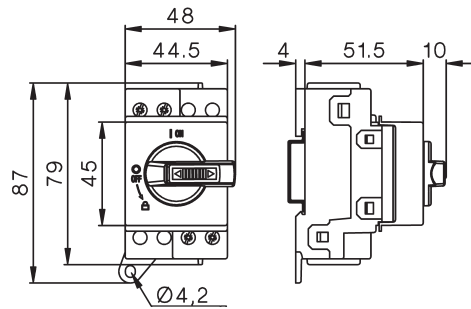

LSM16 SMAH1N..., LSM25 SMAH1N...,
..A2+2, ..A4

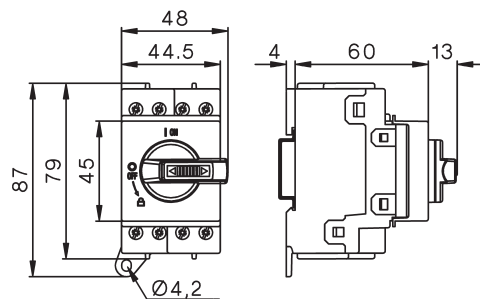

Abmessungen:

LSM16 PFLH4..., LSM25 PFLH4...,
..A2, ..A2+2, ..A4

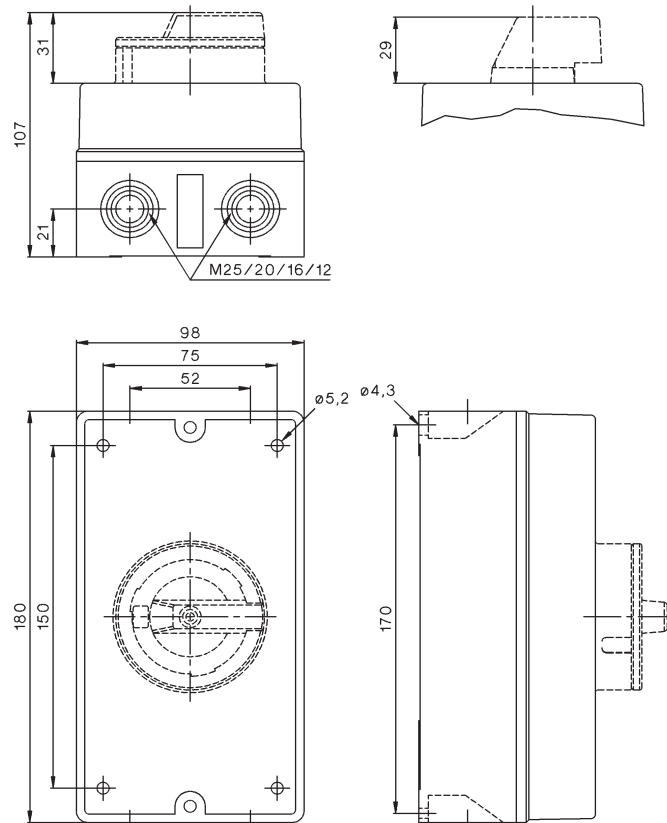



Qualität aus Österreich 

D1024D171



Lieblgasse 7, A-1220 Wien
Telefon: +43 1 251 51- 0
Fax: +43 1 251 51-89
e-mail: sales@benedict.at
www.benedict.at

