















Inhalt		Seite
	Hauptschalter für Einbau 4-Lochbefestigung	280
	Umschalter mit Sperrvorrichtung für Einbau 4-Lochbefestigung	281
	Hauptschalter für Zentralbefestigung	281
	Hauptschalter für Bodenmontage	282
	Hauptschalter-Not-Aus für Einbau 4-Lochbefestigung	286
	Umschalter mit Sperrvorrichtung für Einbau 4-Lochbefestigung	287
	Hauptschalter-Not-Aus für Zentralbefestigung	287
	Hauptschalter-Not-Aus für Bodenmontage	288
	Hauptschalter-Not-Aus für Reiheneinbau	290
	Umschalter mit Sperrvorrichtung für Reiheneinbau	290
	Reparaturschalter, isolierstoffgekapselt	291
	Umschalter mit Sperrvorrichtung	291
	Lasttrennschalter für Einbau, Ein-Ausschalter	292
	Lasttrennschalter für Zentralbefestigung, Ein-Ausschalter	293
	Lasttrennschalter für Bodenmontage	293
	Lasttrennschalter für Reiheneinbau	295
	Lasttrennschalter für Einbau, isolierstoffgekapselt	296
	Zusatzmodule	297
	Technische Daten	299
	Maße	300

Nennwerte								Einbau 4-Lochbefestigung IP66	Zentralbefestigung Ø22,5mm IP66				
	Schutzart von vorne im eingebauten Zustand												
Typ	Nennbetriebsstrom			Motor			Schild Lasttrenn- schalter mm	EH4	EHN4	EHN1	Z	ZHN1	ZH1
	Therm. $I_{th}$ A	offen AC21 A	bei $U_e$ V	AC3 3~400V kW	AC23 3~400V A	AC23 3~400V kW							
LTS20	20	20	690	5,5	16	7,5	48□	LTS20 E <sup>1)</sup> ..			LTS20 Z <sup>1)</sup> ..		
LTS25	25	25	690	7,5	20	10	48□	LTS25 E <sup>1)</sup> ..			LTS25 Z <sup>1)</sup> ..		
LTS32	32	32	690	11	25	12,5	48□	LTS32 E <sup>1)</sup> ..			LTS32 Z <sup>1)</sup> ..		
LTS40	40	40	690	15	32	16	48□	LTS40 E <sup>1)</sup> ..			LTS40 Z <sup>1)</sup> ..		
LTS63	63	63	690	18,5	45	22	48□	LTS63 E <sup>1)</sup> ..			-		
LTS80	80	80	690	18,5	45	22	48□	LTS80 E <sup>1)</sup> ..			-		
LTS85	85	85	690	22	60	30	64□	LTS85 E <sup>1)</sup> ..			-		
LTS100	100	100	690	30	72	37	64□	LTS100 E <sup>1)</sup> ..			-		
LTS125	125	125	690	37	85	45	64□	LTS125 E <sup>1)</sup> ..			-		
LT160	160	160	690	45	110	55	88□	LT160 E <sup>1)</sup> ..			-		

### Lasttrennschalter LT(S).. 20 - 160A

Der Einsatzbereich der Lasttrennschalter ist überall dort gegeben, wo kompakte EIN-AUS-Schalter mit großer Kontaktöffnung (Trenner) und hohem Kontaktdruck und damit größerer Kurzschlußfestigkeit benötigt werden. Die Anwendung erfolgt daher als

**Hauptschalter** nach IEC/EN 60204 bzw. VDE0113 mit Sperrvorrichtung, Klemmenabdeckung und zwangsweiser Kontaktbetätigung.

**Trennschalter** nach IEC/EN 60947-3 und VDE 0660 Teil 107 mit Trennstrecken für 690V.

**Motorschalter** 3-polig oder 4-polig. Entsprechend IEC/EN 60947-3 bzw. VDE 0660 Teil 107 haben die Schalter der LT(S)-Reihe hohes AC3- und AC23A-Schaltvermögen.

### Schaltprogramme

Ein-Ausschalter 3-polig	.. ....	A3
Ein-Ausschalter 4-polig	.. ....	A4
Ein-Ausschalter 6-polig	.. ....	A6
Ein-Ausschalter 8-polig	.. ....	A8
Umschalter mit 0-Stellung 3-polig	.. ....	U3
Umschalter mit 0-Stellung 4-polig	.. ....	U4
Ein-Ausschalter 3-polig	.. ....	T300 (für LT160)
Ein-Ausschalter 4-polig	.. ....	T400 (für LT160)

### Hauptschalter und Hauptschalter mit Not-Aus-Funktion

Jede Be- und Verarbeitungsmaschine muß nach den Vorschriften IEC/EN 60204 bzw. VDE0113 mit einem Hauptschalter ausgerüstet sein, der die gesamte elektrische Ausrüstung während Reinigungs-, Wartungs- und Reparaturarbeiten sowie bei längeren Stillstandszeiten von allen aktiven Leitern der Netzeinspeisung trennt.

Sind 2 oder mehr Hauptschalter vorgesehen, müssen entsprechende Schutzverriegelungen verwendet werden. Empfehlenswert ist jedoch die Verwendung eines vielpoligen Hauptschalters (Nockenschalter).

Der **Hauptschalter** muß einer der folgenden Arten entsprechen:

- Lasttrennschalter entsprechend IEC/EN 60947-3 und VDE 0660 Teil 107 für Anwendungskategorie AC23-B oder DC-23B.
- Trennschalter mit Hilfskontakt (z.B.: Schaltprogramm A3-10), der auf jeden Fall veranlaßt, daß Schalteinrichtungen die Last vor dem Öffnen der Hauptkontakte des Trenners abschalten.
- Das Ausschaltvermögen muß ausreichend sein, den Strom des größten Motors im blockierten Zustand zusammen mit der Summe der Betriebsströme aller übrigen Motoren und/oder Verbraucher abzuschalten.

Anforderungen:

Trennen der elektrischen Ausrüstung vom Netz, wobei nur eine Aus- und eine Ein-Stellung vorhanden ist, eindeutig gekennzeichnet mit O und I. Er muß in der Aus-Stellung abschließbar sein.

Die Netzklemmen eines Hauptschalters müssen gegen zufälliges Berühren mindestens der Schutzart IP2X entsprechen.

Farbe der Handhabe schwarz oder grau.

Der **Hauptschalter mit Not-Aus-Funktion** muß zusätzlich mit einem roten Schaltergriff ausgerüstet sein, das Frontschild hinter dem Schaltergriff muß gelb gefärbt sein, damit sich der Griff deutlich abhebt.

1) Hauptschalter (H1/H4 Hauptschalter Not-Aus (HN1/HN4))  
Lasttrennschalter (ohne H(N)1/4)

Verteilereinbau mit Türkupplung Griff Zentralbefestigung Ø22,5mm IP66			Verteilereinbau m. Türkupplung Einbau 4-Lochbefestigung IP66			Reiheneinbau IP40			Preßstoff-gekapselt IP66		
VZVH4	VZVHN4	VZVHN1	VH4	VHN4	VH1	SMA	SMAHN1	SMAH1	PF(L <sup>2</sup> )H4	PF(L <sup>2</sup> )HN4	PF(L <sup>2</sup> )
LTS20 VZV <sup>1)</sup> ..			LTS20 V <sup>1)</sup> ..			LTS20 SMA <sup>1)</sup> ..			LTS20 PF(L <sup>2</sup> ) <sup>1)</sup> ..		
LTS25 VZV <sup>1)</sup> ..			LTS25 V <sup>1)</sup> ..			LTS25 SMA <sup>1)</sup> ..			LTS25 PF(L <sup>2</sup> ) <sup>1)</sup> ..		
LTS32 VZV <sup>1)</sup> ..			LTS32 V <sup>1)</sup> ..			LTS32 SMA <sup>1)</sup> ..			LTS32 PF(L <sup>2</sup> ) <sup>1)</sup> ..		
LTS40 VZV <sup>1)</sup> ..			LTS40 V <sup>1)</sup> ..			LTS40 SMA <sup>1)</sup> ..			LTS40 PF(L <sup>2</sup> ) <sup>1)</sup> ..		
LTS63 VZV <sup>1)</sup> ..			LTS63 V <sup>1)</sup> ..			LTS63 SMA <sup>1)</sup> ..			LTS63 PFL <sup>1)</sup> ..		
LTS80 VZV <sup>1)</sup> ..			LTS80 V <sup>1)</sup> ..			LTS80 SMA <sup>1)</sup> ..			LTS80 PFL <sup>1)</sup> ..		
LTS85 VZV <sup>1)</sup> ..			LTS85 V <sup>1)</sup> ..			LTS85 SMA <sup>1)</sup> ..			LTS85 PFL <sup>1)</sup> ..		
LTS100 VZV <sup>1)</sup> ..			LTS100 V <sup>1)</sup> ..			LTS100 SMA <sup>1)</sup> ..			LTS100 PFL <sup>1)</sup> ..		
LTS125 VZV <sup>1)</sup> ..			LTS125 V <sup>1)</sup> ..			LTS125 SMA <sup>1)</sup> ..			LTS125 PFL <sup>1)</sup> ..		
-			LT160 V <sup>1)</sup> ..			-			LT160 PF <sup>1)</sup> .. <sup>3)</sup>		

Approbationen				
Land	USA, Kanada / UL	Europa	Russland / EAC	CB/CCA-Zertifikate
Typ				

Lasttrennschalter (UL-Listed as MANUAL MOTOR CONTROLLER and suitable as MOTOR DISCONNECT)				
LTS20	o	/	o	o
LTS25	o	/	o	o
LTS32	o	/	o	o
LTS40	o	/	o	o
LTS63	o	/	o	o
LTS80	o	/	o	o
LTS85	o	/	-	-
LTS100	o	/	-	-
LTS125	o	/	-	-
LT160	o	/	-	o



o in Normalausführung approbiert  
/ Approbation nicht erforderlich CE  
x zur Approbation eingereicht  
- bisher nicht zur Approbation vorgesehen

Klemmenanschlußschrauben					
Geräte	Anschlußart	Schraubendreher	Anzugsdrehmoment		Schutzart
Typ	Schraube mit Zugbügel		Nm	lb. inch	der Anschlußklemmen <sup>4)</sup>
<b>Lasttrennschalter</b>					
LTS20, LTS25	M3,5		1,7 - 2,3	15 - 20	IP20
LTS32, LTS40	M5		2,8 - 4	25 - 35	IP20
LTS63, LTS80	M6		1,7 - 4,5	15 - 40	IP20
LTS85, LTS100, LTS125					
LT160	M10		14	124	IP20



1) Hauptschalter (H1/H4 Hauptschalter Not-Aus (HN1/HN4)) und Lasttrennschalter (ohne H(N)1/4)  
2) PFL... größeres Gehäuse  
3) IP. Type..  
4) Schutzart mit geschlossenem, isoliertem Leiter. Zusatzschutz durch entsprechende Klemmenabdeckung (KLAD).

Schütze, Motorstarter  
Leistungsschalter  
Motorschutzschalter  
Schalter  
AC-Hauptschalter  
DC-Lasttrennschalter  
Befehls- und Meldegeräte  
Vertretungen, Bezugsquellen

# Hauptschalter für Einbau 4-Lochbefestigung, absperrbar IP66, Type 3R

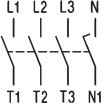
	max. Schlösser	AC21 690V	AC23 3x400V	Schild	Typ	VPE Stk.	Gewicht kg/Stk.
<b>3-polig, Sperrvorrichtung SV1</b>  	2						
		20A	<b>7,5kW</b>	48 □ <sup>1)</sup>	LTS20 EH1 A3	1	0,15
		25A	<b>10kW</b>	48 □ <sup>1)</sup>	LTS25 EH1 A3	1	0,15
		32A	<b>12,5kW</b>	48 □ <sup>1)</sup>	LTS32 EH1 A3	1	0,15
		40A	<b>16kW</b>	48 □ <sup>1)</sup>	LTS40 EH1 A3	1	0,15
		63A	<b>22kW</b>	48 □ <sup>1)</sup>	LTS63 EH1 A3	1	0,17
		80A	<b>22kW</b>	48 □ <sup>1)</sup>	LTS80 EH1 A3	1	0,17

<b>4-polig, Sperrvorrichtung SV1</b>  	2						
		20A	<b>7,5kW</b>	48 □ <sup>1)</sup>	LTS20 EH1 A4	1	0,19
		25A	<b>10kW</b>	48 □ <sup>1)</sup>	LTS25 EH1 A4	1	0,19
		32A	<b>12,5kW</b>	48 □ <sup>1)</sup>	LTS32 EH1 A4	1	0,19
		40A	<b>16kW</b>	48 □ <sup>1)</sup>	LTS40 EH1 A4	1	0,19
		63A	<b>22kW</b>	48 □ <sup>1)</sup>	LTS63 EH1 A4	1	0,21
		80A	<b>22kW</b>	48 □ <sup>1)</sup>	LTS80 EH1 A4	1	0,21

<b>3-polig, Sperrvorrichtung SV4(34)</b>  	3						
		20A	<b>7,5kW</b>	64 □ <sup>2)</sup>	LTS20 EH4 A3	1	0,17
		25A	<b>10kW</b>	64 □ <sup>2)</sup>	LTS25 EH4 A3	1	0,17
		32A	<b>12,5kW</b>	64 □ <sup>2)</sup>	LTS32 EH4 A3	1	0,17
		40A	<b>16kW</b>	64 □ <sup>2)</sup>	LTS40 EH4 A3	1	0,17
		63A	<b>22kW</b>	64 □ <sup>2)</sup>	LTS63 EH4 A3	1	0,19
		80A	<b>22kW</b>	64 □ <sup>2)</sup>	LTS80 EH4 A3	1	0,19
		80A	<b>30kW</b>	64 □ <sup>2)</sup>	LTS85 EH4 A3	1	0,39
		100A	<b>37kW</b>	64 □ <sup>2)</sup>	LTS100 EH4 A3	1	0,39
		125A	<b>45kW</b>	64 □ <sup>2)</sup>	LTS125 EH4 A3	1	0,39

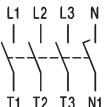
<b>4-polig, Sperrvorrichtung SV4(34)</b>  	3						
		20A	<b>7,5kW</b>	64 □ <sup>2)</sup>	LTS20 EH4 A4	1	0,20
		25A	<b>10kW</b>	64 □ <sup>2)</sup>	LTS25 EH4 A4	1	0,20
		32A	<b>12,5kW</b>	64 □ <sup>2)</sup>	LTS32 EH4 A4	1	0,20
		40A	<b>16kW</b>	64 □ <sup>2)</sup>	LTS40 EH4 A4	1	0,20
		63A	<b>22kW</b>	64 □ <sup>2)</sup>	LTS63 EH4 A4	1	0,23
		80A	<b>22kW</b>	64 □ <sup>2)</sup>	LTS80 EH4 A4	1	0,23
		80A	<b>30kW</b>	64 □ <sup>2)</sup>	LTS85 EH4 A4	1	0,44
		100A	<b>37kW</b>	64 □ <sup>2)</sup>	LTS100 EH4 A4	1	0,44
		125A	<b>45kW</b>	64 □ <sup>2)</sup>	LTS125 EH4 A4	1	0,44

**Zusatzmodule** siehe Seite 297





Verlängerte Schalterwelle für Schalter für Fronteinbau Typenzusatz: **+VV“x“**

x = Paneelstärke



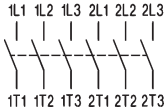

1) Auf Anfrage auch in Schildgröße 64 □ erhältlich, Typenzusatz **64** z. B: LTS32 EHN164 A3

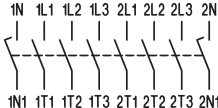
2) Auf Anfrage auch in Schildgröße 88 □ erhältlich, Typenzusatz **88** z. B: LTS32 EHN488 A3



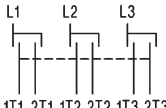

## Hauptschalter für Einbau 4-Lochbefestigung, absperrrbar IP66, Type 3R

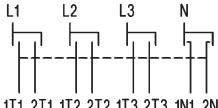
	max. Schlösser	AC21 690V	AC23 3x400V	Schild	Typ	VPE Stk.	Gewicht kg/Stk.
<b>6-polig, Sperrvorrichtung SV4</b> 							
		20A	<b>7,5kW</b>	64 □	LTS20 EH4 A6	1	0,30
		25A	<b>10kW</b>	64 □	LTS25 EH4 A6	1	0,30
		32A	<b>12,5kW</b>	64 □	LTS32 EH4 A6	1	0,30
		40A	<b>16kW</b>	64 □	LTS40 EH4 A6	1	0,30
		63A	<b>22kW</b>	64 □	LTS63 EH4 A6	1	0,34
		80A	<b>22kW</b>	64 □	LTS80 EH4 A6	1	0,34
<b>8-polig, Sperrvorrichtung SV4</b> 							
		20A	<b>7,5kW</b>	64 □	LTS20 EH4 A8	1	0,38
		25A	<b>10kW</b>	64 □	LTS25 EH4 A8	1	0,38
		32A	<b>12,5kW</b>	64 □	LTS32 EH4 A8	1	0,38
		40A	<b>16kW</b>	64 □	LTS40 EH4 A8	1	0,38
		63A	<b>22kW</b>	64 □	LTS63 EH4 A8	1	0,42
		80A	<b>22kW</b>	64 □	LTS80 EH4 A8	1	0,42

## Umschalter mit Sperrvorrichtung für Einbau 4-Lochbefestigung, absperrrbar IP66

	max. Schlösser	AC21 690V	AC23 3x400V	Schild	Typ	VPE Stk.	Gewicht kg/Stk.
<b>3-polig, Sperrvorrichtung SV4</b> 							
		20A	<b>7,5kW</b>	64 □	LTS20 EH4 U3	1	0,30
		25A	<b>10kW</b>	64 □	LTS25 EH4 U3	1	0,30
		32A	<b>12,5kW</b>	64 □	LTS32 EH4 U3	1	0,30
		40A	<b>16kW</b>	64 □	LTS40 EH4 U3	1	0,30
		63A	<b>22kW</b>	64 □	LTS63 EH4 U3	1	0,34
<b>4-polig, Sperrvorrichtung SV4</b> 							
		20A	<b>7,5kW</b>	64 □	LTS20 EH4 U4	1	0,38
		25A	<b>10kW</b>	64 □	LTS25 EH4 U4	1	0,38
		32A	<b>12,5kW</b>	64 □	LTS32 EH4 U4	1	0,38
		40A	<b>16kW</b>	64 □	LTS40 EH4 U4	1	0,38
		63A	<b>22kW</b>	64 □	LTS63 EH4 U4	1	0,42

## Hauptschalter für Zentralbefestigung, absperrrbar IP66, Type 4X

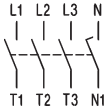
	max. Schlösser	AC21 690V	AC23 3x400V	Schild	Typ	VPE Stk.	Gewicht kg/Stk.
<b>3-polig, Sperrvorrichtung SV1</b> 							
		20A	<b>7,5kW</b>	48 □	LTS20 ZH1 A3	1	0,16
		25A	<b>10kW</b>	48 □	LTS25 ZH1 A3	1	0,16
		32A	<b>12,5kW</b>	48 □	LTS32 ZH1 A3	1	0,16
		40A	<b>16kW</b>	48 □	LTS40 ZH1 A3	1	0,16
<b>4-polig, Sperrvorrichtung SV1</b> 							
		20A	<b>7,5kW</b>	48 □	LTS20 ZH1 A4	1	0,20
		25A	<b>10kW</b>	48 □	LTS25 ZH1 A4	1	0,20
		32A	<b>12,5kW</b>	48 □	LTS32 ZH1 A4	1	0,20
		40A	<b>16kW</b>	48 □	LTS40 ZH1 A4	1	0,20

Zusatzmodule siehe Seite 297

Hauptschalter, Bodenmontage mit Türkupplung, Sperrvorrichtung für Zentralbefestigung Ø22mm  
Einbautiefe nachträglich einstellbar (Lieferlänge, X<sub>max</sub> siehe unten) IP66, cUL<sub>us</sub> Type 4X

	max. Schösser	AC21 690V	AC23 3x400V	Schild	Typ	VPE Stk.	Gewicht kg/Stk.	
<b>3-polig, Sperrvorrichtung SV4</b> 								
		20A	<b>7,5kW</b>	64 □	LTS20 VZVH4 A3	1	0,19	
		25A	<b>10kW</b>	64 □	LTS25 VZVH4 A3	1	0,19	
		32A	<b>12,5kW</b>	64 □	LTS32 VZVH4 A3	1	0,19	
		40A	<b>16kW</b>	64 □	LTS40 VZVH4 A3	1	0,19	
		63A	<b>22kW</b>	64 □	LTS63 VZVH4 A3	1	0,22	
		80A	<b>22kW</b>	64 □	LTS80 VZVH4 A3	1	0,22	
		85A	<b>30kW</b>	64 □	LTS85 VZVH4 A3	1	0,40	
		100A	<b>37kW</b>	64 □	LTS100 VZVH4 A3	1	0,40	
		125A	<b>45kW</b>	64 □	LTS125 VZVH4 A3	1	0,40	
<b>4-polig, Sperrvorrichtung SV4</b> 								
		20A	<b>7,5kW</b>	64 □	LTS20 VZVH4 A4	1	0,20	
		25A	<b>10kW</b>	64 □	LTS25 VZVH4 A4	1	0,20	
		32A	<b>12,5kW</b>	64 □	LTS32 VZVH4 A4	1	0,20	
		40A	<b>16kW</b>	64 □	LTS40 VZVH4 A4	1	0,20	
		63A	<b>22kW</b>	64 □	LTS63 VZVH4 A4	1	0,26	
		80A	<b>22kW</b>	64 □	LTS80 VZVH4 A4	1	0,26	
		85A	<b>30kW</b>	64 □	LTS85 VZVH4 A4	1	0,45	
		100A	<b>37kW</b>	64 □	LTS100 VZVH4 A4	1	0,45	
		125A	<b>45kW</b>	64 □	LTS125 VZVH4 A4	1	0,45	
<b>6-polig, Sperrvorrichtung SV4</b> 								
		20A	<b>7,5kW</b>	64 □	LTS20 VZVH4 A6	1	0,32	
		25A	<b>10kW</b>	64 □	LTS25 VZVH4 A6	1	0,32	
		32A	<b>12,5kW</b>	64 □	LTS32 VZVH4 A6	1	0,32	
		40A	<b>16kW</b>	64 □	LTS40 VZVH4 A6	1	0,32	
		63A	<b>22kW</b>	64 □	LTS63 VZVH4 A6	1	0,37	
		80A	<b>22kW</b>	64 □	LTS80 VZVH4 A6	1	0,37	
	<b>8-polig, Sperrvorrichtung SV4</b> 							
			20A	<b>7,5kW</b>	64 □	LTS20 VZVH4 A8	1	0,34
			25A	<b>10kW</b>	64 □	LTS25 VZVH4 A8	1	0,34
		32A	<b>12,5kW</b>	64 □	LTS32 VZVH4 A8	1	0,34	
		40A	<b>16kW</b>	64 □	LTS40 VZVH4 A8	1	0,34	
		63A	<b>22kW</b>	64 □	LTS63 VZVH4 A8	1	0,45	
		80A	<b>22kW</b>	64 □	LTS80 VZVH4 A8	1	0,45	

**Einbautiefe**  
Zentralbefestigung Ø22mm  
LTS.. VZV..

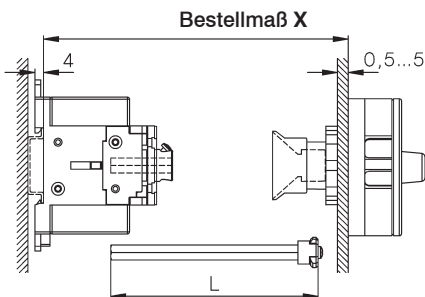

Typ		X min	X max	L
LTS20-80 VZV..	3, 4-polig	91	190	<b>X - 40±3</b>
LTS20-80 VZV..	6, 8-polig	111	190	<b>X - 60±3</b>
LTS85-125 VZV..	3, 4-polig	95	190	<b>X - 44±3</b>

**4-Lochbefestigung**  
LTS.. V(H).. (3, 4-polig)

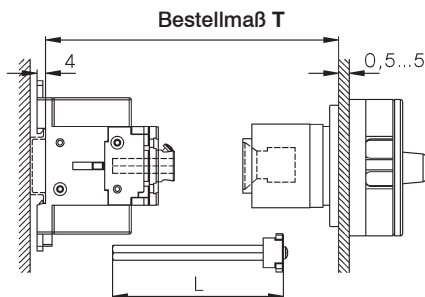





Typ		T min	T max	L	Type	T min	T max
LTS20-80 VH..		111	190	<b>T - 60±3</b>	LTS160 VH..	120	450
LTS85-125 VH..		115	190	<b>T - 64±3</b>			

Größere X- und T-Maße (max. 380mm für LTS..) auf Anfrage



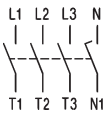

Hauptschalter, Bodenmontage mit Türkupplung, Sperrvorrichtung für 4-Lochbefestigung  
 Einbautiefe nachträglich einstellbar (Lieferlänge,  $T_{max}$  siehe Seite 271) IP66, cUL<sub>us</sub> Type 4X

	max. Schösser	AC21 690V	AC23 3x400V	Schild	Typ	VPE Stk.	Gewicht kg/Stk.
<b>3-polig, Sperrvorrichtung SV4(34)</b> 							
 	20A	<b>7,5kW</b>		64 □ <sup>1)</sup>	LTS20 VH4 A3	1	0,20
	25A	<b>10kW</b>		64 □ <sup>1)</sup>	LTS25 VH4 A3	1	0,20
	32A	<b>12,5kW</b>		64 □ <sup>1)</sup>	LTS32 VH4 A3	1	0,20
	40A	<b>16kW</b>		64 □ <sup>1)</sup>	LTS40 VH4 A3	1	0,20
	63A	<b>22kW</b>		64 □ <sup>1)</sup>	LTS63 VH4 A3	1	0,24
	80A	<b>22kW</b>		64 □ <sup>1)</sup>	LTS80 VH4 A3	1	0,24
	85A	<b>30kW</b>		64 □ <sup>1)</sup>	LTS85 VH4 A3	1	0,40
	100A	<b>37kW</b>		64 □ <sup>1)</sup>	LTS100 VH4 A3	1	0,40
	125A	<b>45kW</b>		64 □ <sup>1)</sup>	LTS125 VH4 A3	1	0,40
	160A	<b>55kW</b>		88 □	LT160 VH34 T300	1	1,38

<b>4-polig, Sperrvorrichtung SV4(34)</b> 							
 	20A	<b>7,5kW</b>		64 □ <sup>1)</sup>	LTS20 VH4 A4	1	0,21
	25A	<b>10kW</b>		64 □ <sup>1)</sup>	LTS25 VH4 A4	1	0,21
	32A	<b>12,5kW</b>		64 □ <sup>1)</sup>	LTS32 VH4 A4	1	0,21
	40A	<b>16kW</b>		64 □ <sup>1)</sup>	LTS40 VH4 A4	1	0,21
	63A	<b>22kW</b>		64 □ <sup>1)</sup>	LTS63 VH4 A4	1	0,28
	80A	<b>22kW</b>		64 □ <sup>1)</sup>	LTS80 VH4 A4	1	0,28
	85A	<b>30kW</b>		64 □ <sup>1)</sup>	LTS85 VH4 A4	1	0,45
	100A	<b>37kW</b>		64 □ <sup>1)</sup>	LTS100 VH4 A4	1	0,45
	125A	<b>45kW</b>		64 □ <sup>1)</sup>	LTS125 VH4 A4	1	0,45
	160A	<b>55kW</b>		88 □	LT160 VH34 T400	1	1,77

Hauptschalter, Bodenmontage mit Stecktürkupplung für Zentralbefestigung Ø22mm  
 Einbautiefe nicht einstellbar, Maß X bei Bestellung angeben IP66, cUL<sub>us</sub> Type 4X

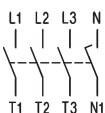
<b>4-polig, Sperrvorrichtung SV4</b> 							
 	20A	<b>7,5kW</b>		64 □	LTS20 VZH4 A4 X..	1	0,18
	25A	<b>10kW</b>		64 □	LTS25 VZH4 A4 X..	1	0,18
	32A	<b>12,5kW</b>		64 □	LTS32 VZH4 A4 X..	1	0,18
	40A	<b>16kW</b>		64 □	LTS40 VZH4 A4 X..	1	0,18
	63A	<b>22kW</b>		64 □	LTS63 VZH4 A4 X..	1	0,25
	80A	<b>22kW</b>		64 □	LTS80 VZH4 A4 X..	1	0,25

Einbautiefe Maß X unbedingt angeben

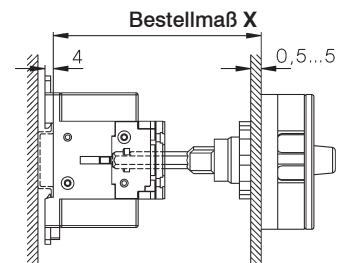

Typ	Vorzugswerte für X
LT.. VZH..	80, 85, 104, 129 (Toleranz -3, +1,5)





Zusatzmodule siehe Seite 297

1) Auf Anfrage auch in Schildgröße 88 □ erhältlich Typenzusatz **88** z. B: LTS32 VH4**88** A3



Hauptschalter, für Reiheneinbau, absperrrbar IP40,  Open Type

	max. Schlösser	AC21 690V	AC23 3x400V	Schild	Typ	VPE Stk.	Gewicht kg/Stk.
<b>3-polig, Sperrvorrichtung SV1</b> 							
		20A	<b>7,5kW</b>	52x45	LTS20 SMAH1 A3 <sup>2)</sup>	1	0,15
		25A	<b>10kW</b>	52x45	LTS25 SMAH1 A3 <sup>2)</sup>	1	0,15
		32A	<b>12,5kW</b>	52x45	LTS32 SMAH1 A3 <sup>2)</sup>	1	0,15
		40A	<b>16kW</b>	52x45	LTS40 SMAH1 A3 <sup>2)</sup>	1	0,15
		63A	<b>22kW</b>	52x45	LTS63 SMAH1 A3 <sup>2)</sup>	1	0,18
		80A	<b>22kW</b>	52x45	LTS80 SMAH1 A3 <sup>2)</sup>	1	0,18
		85A	<b>30kW</b>	78x45	LTS85 SMAH1 A3	1	0,37
		100A	<b>37kW</b>	78x45	LTS100 SMAH1 A3	1	0,37
	125A	<b>45kW</b>	78x45	LTS125 SMAH1 A3	1	0,37	



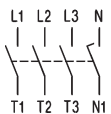

<b>4-polig, Sperrvorrichtung SV1</b> 							
		20A	<b>7,5kW</b>	52x45	LTS20 SMAH1 A4 <sup>2)</sup>	1	0,16
		25A	<b>10kW</b>	52x45	LTS25 SMAH1 A4 <sup>2)</sup>	1	0,16
		32A	<b>12,5kW</b>	52x45	LTS32 SMAH1 A4 <sup>2)</sup>	1	0,16
		40A	<b>16kW</b>	52x45	LTS40 SMAH1 A4 <sup>2)</sup>	1	0,16
		63A	<b>22kW</b>	52x45	LTS63 SMAH1 A4 <sup>2)</sup>	1	0,21
		80A	<b>22kW</b>	52x45	LTS80 SMAH1 A4 <sup>2)</sup>	1	0,21
		85A	<b>30kW</b>	78x45	LTS85 SMAH1 A4	1	0,42
		100A	<b>37kW</b>	78x45	LTS100 SMAH1 A4	1	0,42
	125A	<b>45kW</b>	78x45	LTS125 SMAH1 A4	1	0,42	

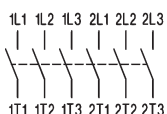

<b>6-polig, Sperrvorrichtung SV1(64)</b> 							
		20A	<b>7,5kW</b>	52x45	LTS20 SMAH1 A6	1	0,29
		25A	<b>10kW</b>	52x45	LTS25 SMAH1 A6	1	0,29
		32A	<b>12,5kW</b>	52x45	LTS32 SMAH1 A6	1	0,29
		40A	<b>16kW</b>	52x45	LTS40 SMAH1 A6	1	0,29
		63A	<b>22kW</b>	97x45	LTS63 SMAH1 A6 <sup>1)</sup>	1	0,34
		80A	<b>22kW</b>	97x45	LTS80 SMAH1 A6 <sup>1)</sup>	1	0,34



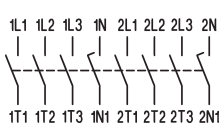

<b>8-polig, Sperrvorrichtung SV164</b> 							
		20A	<b>7,5kW</b>	97x45	LTS20 SMAH1 A8	1	0,31
		25A	<b>10kW</b>	97x45	LTS25 SMAH1 A8	1	0,31
		32A	<b>12,5kW</b>	97x45	LTS32 SMAH1 A8	1	0,31
		40A	<b>16kW</b>	97x45	LTS40 SMAH1 A8	1	0,31
		63A	<b>22kW</b>	126x45	LTS63 SMAH1 A8	1	0,42
		80A	<b>22kW</b>	126x45	LTS80 SMAH1 A8	1	0,42

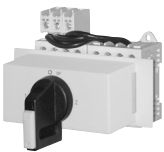

**Umschalter mit Sperrvorrichtung für Reiheneinbau, absperrrbar**

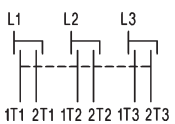
<b>3-polig, Sperrvorrichtung SV164</b> 							
		20A	<b>7,5kW</b>	97x45	LTS20 SMAH1 U3	1	0,29
		25A	<b>10kW</b>	97x45	LTS25 SMAH1 U3	1	0,29
		32A	<b>12,5kW</b>	97x45	LTS32 SMAH1 U3	1	0,29
		40A	<b>16kW</b>	97x45	LTS40 SMAH1 U3	1	0,29
		63A	<b>22kW</b>	97x45	LTS63 SMAH1 U3	1	0,34

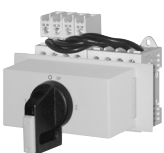

<b>4-polig, Sperrvorrichtung SV164</b> 							
		20A	<b>7,5kW</b>	97x45	LTS20 SMAH1 U4	1	0,31
		25A	<b>10kW</b>	97x45	LTS25 SMAH1 U4	1	0,31
		32A	<b>12,5kW</b>	97x45	LTS32 SMAH1 U4	1	0,31
		40A	<b>16kW</b>	97x45	LTS40 SMAH1 U4	1	0,31
		63A	<b>22kW</b>	126x45	LTS63 SMAH1 U4	1	0,42

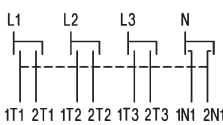















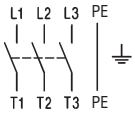



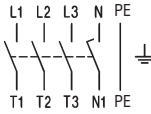



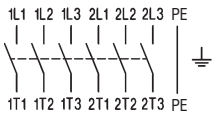

1) mit Sperrvorrichtung SV164

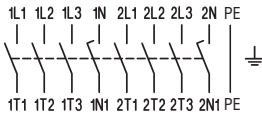
2) **Hauptschalter-Not-Aus, für Reiheneinbau**, absperrrbar mit **niedrigem Griff**, IP40

Typ mit Typenzusatz „+SV1N“ z.B.: **LTS40 SMAH1 A3 +SV1**

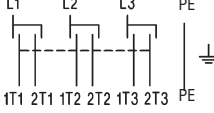



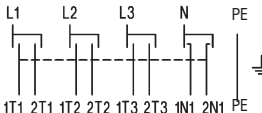



# Reparaturschalter isolierstoffgekapselt, absperrbar IP66, $c_{UL}$ us Type 4X

	max. Schösser	AC21 690V	AC23 3x400V	Schild	Typ	VPE Stk.	Gewicht kg/Stk.	
<b>3-polig, Sperrvorrichtung SV4(34)</b>   								
 	20A	<b>7,5kW</b>		64 □	LTS20 PF(L <sup>1</sup> )H4 A3	1	0,32	
	25A	<b>10kW</b>		64 □	LTS25 PF(L <sup>1</sup> )H4 A3	1	0,32	
	32A	<b>12,5kW</b>		64 □	LTS32 PF(L <sup>1</sup> )H4 A3	1	0,32	
	40A	<b>16kW</b>		64 □	LTS40 PF(L <sup>1</sup> )H4 A3	1	0,32	
	63A	<b>22kW</b>		64 □	LTS63 PFLH4 A3	1	0,60	
	80A	<b>22kW</b>		64 □	LTS80 PFLH4 A3	1	0,60	
	85A	<b>30kW</b>		64 □	LTS85 PFLH4 A3	1	0,78	
	100A	<b>37kW</b>		64 □	LTS100 PFLH4 A3	1	0,78	
	125A	<b>45kW</b>		64 □	LTS125 PFLH4 A3	1	0,78	
	160A	<b>55kW</b>		88 □	LT160 PFH34 T300	1	2,09	
Größeres Gehäuse Typ: ..PFL..		auf Anfrage						
<b>4-polig, Sperrvorrichtung SV4(34)</b>   								
 	20A	<b>7,5kW</b>		64 □	LTS20 PF(L <sup>1</sup> )H4 A4	1	0,33	
	25A	<b>10kW</b>		64 □	LTS25 PF(L <sup>1</sup> )H4 A4	1	0,33	
	32A	<b>12,5kW</b>		64 □	LTS32 PF(L <sup>1</sup> )H4 A4	1	0,33	
	40A	<b>16kW</b>		64 □	LTS40 PF(L <sup>1</sup> )H4 A4	1	0,33	
	63A	<b>22kW</b>		64 □	LTS63 PFLH4 A4	1	0,64	
	80A	<b>22kW</b>		64 □	LTS80 PFLH4 A4	1	0,64	
	85A	<b>30kW</b>		64 □	LTS85 PFLH4 A4	1	0,83	
	100A	<b>37kW</b>		64 □	LTS100 PFLH4 A4	1	0,83	
	125A	<b>45kW</b>		64 □	LTS125 PFLH4 A4	1	0,83	
	160A	<b>55kW</b>		88 □	LT160 PFH34 T400	1	2,47	
Größeres Gehäuse Typenzusatz +PF3		auf Anfrage						
+PF3/M50		auf Anfrage						
<b>6-polig, Sperrvorrichtung SV4</b>   								
 	20A	<b>7,5kW</b>		64 □	LTS20 PFLH4 A6	1	1,39	
	25A	<b>10kW</b>		64 □	LTS25 PFLH4 A6	1	1,39	
	32A	<b>12,5kW</b>		64 □	LTS32 PFLH4 A6	1	1,39	
	40A	<b>16kW</b>		64 □	LTS40 PFLH4 A6	1	1,39	
	63A	<b>22kW</b>		64 □	LTS63 PFLH4 A6	1	1,42	
	80A	<b>22kW</b>		64 □	LTS80 PFLH4 A6	1	1,42	
	Anbauerschraubung M50/40		auf Anfrage					
	+PF3/M50		auf Anfrage					
	<b>8-polig, Sperrvorrichtung SV4</b>   							
	 	20A	<b>7,5kW</b>		64 □	LTS20 PFLH4 A8	1	1,44
25A		<b>10kW</b>		64 □	LTS25 PFLH4 A8	1	1,44	
32A		<b>12,5kW</b>		64 □	LTS32 PFLH4 A8	1	1,44	
40A		<b>16kW</b>		64 □	LTS40 PFLH4 A8	1	1,44	
63A		<b>22kW</b>		64 □	LTS63 PFLH4 A8	1	1,50	
80A		<b>22kW</b>		64 □	LTS80 PFLH4 A8	1	1,50	
Anbauerschraubung M50/40		auf Anfrage						
+PF3/M50		auf Anfrage						
<b>Umschalter mit Sperrvorrichtung, absperrbar</b>								
<b>3-polig, Sperrvorrichtung SV4</b>   								
 	20A	<b>7,5kW</b>		64 □	LTS20 PFLH4 U3	1	1,39	
	25A	<b>10kW</b>		64 □	LTS25 PFLH4 U3	1	1,39	
	32A	<b>12,5kW</b>		64 □	LTS32 PFLH4 U3	1	1,39	
	40A	<b>16kW</b>		64 □	LTS40 PFLH4 U3	1	1,39	
	63A	<b>22kW</b>		64 □	LTS63 PFLH4 U3	1	1,42	
	Anbauerschraubung M50/40		auf Anfrage					
+PF3/M50		auf Anfrage						
<b>4-polig, Sperrvorrichtung SV4</b>   								
 	20A	<b>7,5kW</b>		64 □	LTS20 PFLH4 U4	1	1,44	
	25A	<b>10kW</b>		64 □	LTS25 PFLH4 U4	1	1,44	
	32A	<b>12,5kW</b>		64 □	LTS32 PFLH4 U4	1	1,44	
	40A	<b>16kW</b>		64 □	LTS40 PFLH4 U4	1	1,44	
	63A	<b>22kW</b>		64 □	LTS63 PFLH4 U4	1	1,50	
	Anbauerschraubung M50/40		auf Anfrage					
+PF3/M50		auf Anfrage						

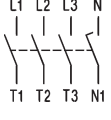
1) PFL.... größerer Anschlußraum

Hauptschalter-Not-Aus, für Einbau 4-Lochbefestigung, absperrbar IP66,  Type 3R

	max. Schösser	AC21 690V	AC23 3x400V	Schild	Typ	VPE Stk.	Gewicht kg/Stk.
<b>3-polig, Sperrvorrichtung SV1</b> 							
		20A	<b>7,5kW</b>	48 □ <sup>1)</sup>	LTS20 EHN1 A3	1	0,15
		25A	<b>10kW</b>	48 □ <sup>1)</sup>	LTS25 EHN1 A3	1	0,15
		32A	<b>12,5kW</b>	48 □ <sup>1)</sup>	LTS32 EHN1 A3	1	0,15
		40A	<b>16kW</b>	48 □ <sup>1)</sup>	LTS40 EHN1 A3	1	0,15
		63A	<b>22kW</b>	48 □ <sup>1)</sup>	LTS63 EHN1 A3	1	0,17
		80A	<b>22kW</b>	48 □ <sup>1)</sup>	LTS80 EHN1 A3	1	0,17
<b>4-polig, Sperrvorrichtung SV1</b> 							
		20A	<b>7,5kW</b>	48 □ <sup>1)</sup>	LTS20 EHN1 A4	1	0,19
		25A	<b>10kW</b>	48 □ <sup>1)</sup>	LTS25 EHN1 A4	1	0,19
		32A	<b>12,5kW</b>	48 □ <sup>1)</sup>	LTS32 EHN1 A4	1	0,19
		40A	<b>16kW</b>	48 □ <sup>1)</sup>	LTS40 EHN1 A4	1	0,19
		63A	<b>22kW</b>	48 □ <sup>1)</sup>	LTS63 EHN1 A4	1	0,21
		80A	<b>22kW</b>	48 □ <sup>1)</sup>	LTS80 EHN1 A4	1	0,21
<b>3-polig, Sperrvorrichtung SV4(34)</b> 							
		20A	<b>7,5kW</b>	64 □ <sup>2)</sup>	LTS20 EHN4 A3	1	0,17
		25A	<b>10kW</b>	64 □ <sup>2)</sup>	LTS25 EHN4 A3	1	0,17
		32A	<b>12,5kW</b>	64 □ <sup>2)</sup>	LTS32 EHN4 A3	1	0,17
		40A	<b>16kW</b>	64 □ <sup>2)</sup>	LTS40 EHN4 A3	1	0,17
		63A	<b>22kW</b>	64 □ <sup>2)</sup>	LTS63 EHN4 A3	1	0,19
		80A	<b>22kW</b>	64 □ <sup>2)</sup>	LTS80 EHN4 A3	1	0,19
		85A	<b>30kW</b>	64 □ <sup>2)</sup>	LTS85 EHN4 A3	1	0,39
		100A	<b>37kW</b>	64 □ <sup>2)</sup>	LTS100 EHN4 A3	1	0,39
		125A	<b>45kW</b>	64 □ <sup>2)</sup>	LTS125 EHN4 A3	1	0,39
		160A	<b>55kW</b>	88 □	LT160 EHN34 T300	1	1,16
<b>4-polig, Sperrvorrichtung SV4(34)</b> 							
		20A	<b>7,5kW</b>	64 □ <sup>2)</sup>	LTS20 EHN4 A4	1	0,20
		25A	<b>10kW</b>	64 □ <sup>2)</sup>	LTS25 EHN4 A4	1	0,20
		32A	<b>12,5kW</b>	64 □ <sup>2)</sup>	LTS32 EHN4 A4	1	0,20
		40A	<b>16kW</b>	64 □ <sup>2)</sup>	LTS40 EHN4 A4	1	0,20
		63A	<b>22kW</b>	64 □ <sup>2)</sup>	LTS63 EHN4 A4	1	0,23
		80A	<b>22kW</b>	64 □ <sup>2)</sup>	LTS80 EHN4 A4	1	0,23
		85A	<b>30kW</b>	64 □ <sup>2)</sup>	LTS85 EHN4 A4	1	0,44
		100A	<b>37kW</b>	64 □ <sup>2)</sup>	LTS100 EHN4 A4	1	0,44
		125A	<b>45kW</b>	64 □ <sup>2)</sup>	LTS125 EHN4 A4	1	0,44
		160A	<b>55kW</b>	88 □	LT160 EHN34 T400	1	1,55

**Zusatzmodule** siehe Seite 297





Verlängerte Schalterwelle für Schalter für Fronteinbau Typenzusatz: **+VW“x“**

x = Paneelstärke



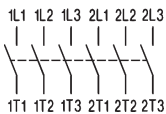

1) Auf Anfrage auch in Schildgröße 64 □ erhältlich, Typenzusatz **64** z. B: LTS32 EHN164 A3

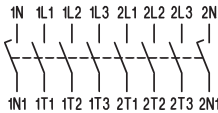
2) Auf Anfrage auch in Schildgröße 88 □ erhältlich, Typenzusatz **88** z. B: LTS32 EHN488 A3



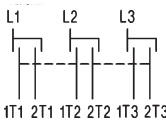

# Hauptschalter-Not-Aus, für Einbau 4-Lochbefestigung, absperrbar IP66, Type 3R

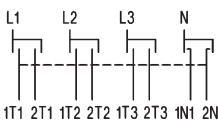
	max. Schösser	AC21 690V	AC23 3x400V	Schild	Typ	VPE Stk.	Gewicht kg/Stk.
<b>6-polig, Sperrvorrichtung SV4</b> 							
		20A	<b>7,5kW</b>	64 □	LTS20 EHN4 A6	1	0,30
		25A	<b>10kW</b>	64 □	LTS25 EHN4 A6	1	0,30
		32A	<b>12,5kW</b>	64 □	LTS32 EHN4 A6	1	0,30
		40A	<b>16kW</b>	64 □	LTS40 EHN4 A6	1	0,30
		63A	<b>22kW</b>	64 □	LTS63 EHN4 A6	1	0,34
		80A	<b>22kW</b>	64 □	LTS80 EHN4 A6	1	0,34
<b>8-polig, Sperrvorrichtung SV4</b> 							
		20A	<b>7,5kW</b>	64 □	LTS20 EHN4 A8	1	0,38
		25A	<b>10kW</b>	64 □	LTS25 EHN4 A8	1	0,38
		32A	<b>12,5kW</b>	64 □	LTS32 EHN4 A8	1	0,38
		40A	<b>16kW</b>	64 □	LTS40 EHN4 A8	1	0,38
		63A	<b>22kW</b>	64 □	LTS63 EHN4 A8	1	0,42
		80A	<b>22kW</b>	64 □	LTS80 EHN4 A8	1	0,42

## Umschalter mit Sperrvorrichtung für Einbau 4-Lochbefestigung, absperrbar IP66

<b>3-polig, Sperrvorrichtung SV4</b> 							
		20A	<b>7,5kW</b>	64 □	LTS20 EHN4 U3	1	0,30
		25A	<b>10kW</b>	64 □	LTS25 EHN4 U3	1	0,30
		32A	<b>12,5kW</b>	64 □	LTS32 EHN4 U3	1	0,30
		40A	<b>16kW</b>	64 □	LTS40 EHN4 U3	1	0,30
		63A	<b>22kW</b>	64 □	LTS63 EHN4 U3	1	0,34
<b>4-polig, Sperrvorrichtung SV4</b> 							
		20A	<b>7,5kW</b>	64 □	LTS20 EHN4 U4	1	0,38
		25A	<b>10kW</b>	64 □	LTS25 EHN4 U4	1	0,38
		32A	<b>12,5kW</b>	64 □	LTS32 EHN4 U4	1	0,38
		40A	<b>16kW</b>	64 □	LTS40 EHN4 U4	1	0,38
		63A	<b>22kW</b>	64 □	LTS63 EHN4 U4	1	0,42

## Hauptschalter-Not-Aus, für Zentralbefestigung, absperrbar IP66 Type 4X

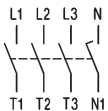
	max. Schösser	AC21 690V	AC23 3x400V	Schild	Typ	VPE Stk.	Gewicht kg/Stk.
<b>3-polig, Sperrvorrichtung SV1</b> 							
		20A	<b>7,5kW</b>	48 □	LTS20 ZHN1 A3	1	0,16
		25A	<b>10kW</b>	48 □	LTS25 ZHN1 A3	1	0,16
		32A	<b>12,5kW</b>	48 □	LTS32 ZHN1 A3	1	0,16
		40A	<b>16kW</b>	48 □	LTS40 ZHN1 A3	1	0,16
<b>4-polig, Sperrvorrichtung SV1</b> 							
		20A	<b>7,5kW</b>	48 □	LTS20 ZHN1 A4	1	0,20
		25A	<b>10kW</b>	48 □	LTS25 ZHN1 A4	1	0,20
		32A	<b>12,5kW</b>	48 □	LTS32 ZHN1 A4	1	0,20
		40A	<b>16kW</b>	48 □	LTS40 ZHN1 A4	1	0,20

**Zusatzmodule** siehe Seite 297

Hauptschalter-Not-Aus, Bodenmontage mit Türkupplung für Zentralbefestigung Ø22mm  
 Einbautiefe nachträglich einstellbar (Lieferlänge, X<sub>max</sub> siehe unten) IP66, cULus Type 4X

	max. Schösser	AC21 690V	AC23 3x400V	Schild	Typ	VPE Stk.	Gewicht kg/Stk.
<b>3-polig, Sperrvorrichtung SV4</b> 		20A	<b>7,5kW</b>	64 □	LTS20 VZVHN4 A3	1	0,19
		25A	<b>10kW</b>	64 □	LTS25 VZVHN4 A3	1	0,19
		32A	<b>12,5kW</b>	64 □	LTS32 VZVHN4 A3	1	0,19
		40A	<b>16kW</b>	64 □	LTS40 VZVHN4 A3	1	0,19
		63A	<b>22kW</b>	64 □	LTS63 VZVHN4 A3	1	0,22
		80A	<b>22kW</b>	64 □	LTS80 VZVHN4 A3	1	0,22
		85A	<b>30kW</b>	64 □	LTS85 VZVHN4 A3	1	0,40
		100A	<b>37kW</b>	64 □	LTS100 VZVHN4 A3	1	0,40
		125A	<b>45kW</b>	64 □	LTS125 VZVHN4 A3	1	0,40

<b>4-polig, Sperrvorrichtung SV4</b> 		20A	<b>7,5kW</b>	64 □	LTS20 VZVHN4 A4	1	0,20
		25A	<b>10kW</b>	64 □	LTS25 VZVHN4 A4	1	0,20
		32A	<b>12,5kW</b>	64 □	LTS32 VZVHN4 A4	1	0,20
		40A	<b>16kW</b>	64 □	LTS40 VZVHN4 A4	1	0,20
		63A	<b>22kW</b>	64 □	LTS63 VZVHN4 A4	1	0,26
		80A	<b>22kW</b>	64 □	LTS80 VZVHN4 A4	1	0,26
		85A	<b>30kW</b>	64 □	LTS85 VZVHN4 A4	1	0,45
		100A	<b>37kW</b>	64 □	LTS100 VZVHN4 A4	1	0,45
		125A	<b>45kW</b>	64 □	LTS125 VZVHN4 A4	1	0,45

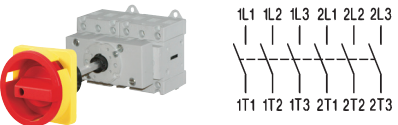
<b>6-polig, Sperrvorrichtung SV4</b> 		20A	<b>7,5kW</b>	64 □	LTS20 VZVHN4 A6	1	0,32
		25A	<b>10kW</b>	64 □	LTS25 VZVHN4 A6	1	0,32
		32A	<b>12,5kW</b>	64 □	LTS32 VZVHN4 A6	1	0,32
		40A	<b>16kW</b>	64 □	LTS40 VZVHN4 A6	1	0,32
		63A	<b>22kW</b>	64 □	LTS63 VZVHN4 A6	1	0,37
		80A	<b>22kW</b>	64 □	LTS80 VZVHN4 A6	1	0,37

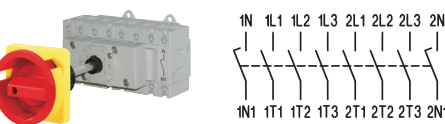
<b>8-polig, Sperrvorrichtung SV4</b> 		20A	<b>7,5kW</b>	64 □	LTS20 VZVHN4 A8	1	0,34
		25A	<b>10kW</b>	64 □	LTS25 VZVHN4 A8	1	0,34
		32A	<b>12,5kW</b>	64 □	LTS32 VZVHN4 A8	1	0,34
		40A	<b>16kW</b>	64 □	LTS40 VZVHN4 A8	1	0,34
		63A	<b>22kW</b>	64 □	LTS63 VZVHN4 A8	1	0,45
		80A	<b>22kW</b>	64 □	LTS80 VZVHN4 A8	1	0,45

**Einbautiefe**  
 Zentralbefestigung Ø22mm  
 LTS.. VZV..

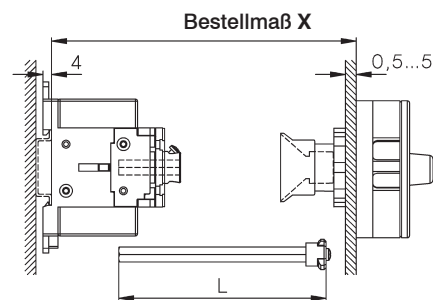

Typ		X min	X max	L
LTS20-80 VZV..	3, 4-polig	91 -	190	<b>X - 40±3</b>
LTS20-80 VZV..	6, 8-polig	111 -	190	<b>X - 60±3</b>
LTS85-125 VZV..	3, 4-polig	95-	190	<b>X - 44±3</b>

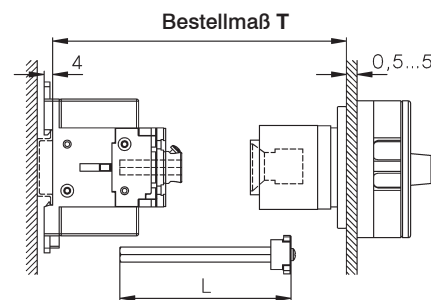

**4-Lochbefestigung**  
 LTS.. V(HN).. (3, 4-polig)



Typ		T min	T max	L	Typ	T min	T max
LTS20-80 VH..		111 -	190	<b>T - 60±3</b>	LTS160 VH..	120 -	450
LTS85-125 VH..		115 -	190	<b>T - 64±3</b>			

Größere X- und T-Maße (max. 380mm für LTS..) auf Anfrage

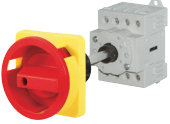
Hauptschalter-Not-Aus, Bodenmontage mit Türkupplung für 4-Lochbefestigung  
Einbautiefe nachträglich einstellbar (Lieferlänge,  $T_{max}$  siehe Seite 282) IP66, cUL<sub>us</sub> Type 4X

	max. Schösser	AC21 690V	AC23 3x400V	Schild	Typ	VPE Stk.	Gewicht kg/Stk.
<b>3-polig, Sperrvorrichtung SV4(34)</b>  							
		20A	<b>7,5kW</b>	64 □ <sup>1)</sup>	LTS20 VHN4 A3	1	0,20
		25A	<b>10kW</b>	64 □ <sup>1)</sup>	LTS25 VHN4 A3	1	0,20
		32A	<b>12,5kW</b>	64 □ <sup>1)</sup>	LTS32 VHN4 A3	1	0,20
		40A	<b>16kW</b>	64 □ <sup>1)</sup>	LTS40 VHN4 A3	1	0,20
		63A	<b>22kW</b>	64 □ <sup>1)</sup>	LTS63 VHN4 A3	1	0,24
		80A	<b>22kW</b>	64 □ <sup>1)</sup>	LTS80 VHN4 A3	1	0,24
		85A	<b>30kW</b>	64 □ <sup>1)</sup>	LTS85 VHN4 A3	1	0,40
		100A	<b>37kW</b>	64 □ <sup>1)</sup>	LTS100 VHN4 A3	1	0,40
		125A	<b>45kW</b>	64 □ <sup>1)</sup>	LTS125 VHN4 A3	1	0,40
		160A	<b>55kW</b>	88 □	LT160 VHN34 T300	1	1,38

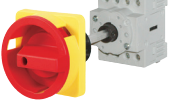
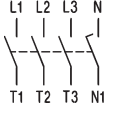
<b>4-polig, Sperrvorrichtung SV4(34)</b>  							
		20A	<b>7,5kW</b>	64 □ <sup>1)</sup>	LTS20 VHN4 A4	1	0,21
		25A	<b>10kW</b>	64 □ <sup>1)</sup>	LTS25 VHN4 A4	1	0,21
		32A	<b>12,5kW</b>	64 □ <sup>1)</sup>	LTS32 VHN4 A4	1	0,21
		40A	<b>16kW</b>	64 □ <sup>1)</sup>	LTS40 VHN4 A4	1	0,21
		63A	<b>22kW</b>	64 □ <sup>1)</sup>	LTS63 VHN4 A4	1	0,28
		80A	<b>22kW</b>	64 □ <sup>1)</sup>	LTS80 VHN4 A4	1	0,28
		85A	<b>30kW</b>	64 □ <sup>1)</sup>	LTS85 VHN4 A4	1	0,45
		100A	<b>37kW</b>	64 □ <sup>1)</sup>	LTS100 VHN4 A4	1	0,45
		125A	<b>45kW</b>	64 □ <sup>1)</sup>	LTS125 VHN4 A4	1	0,45
		160A	<b>55kW</b>	88 □	LT160 VHN34 T400	1	1,77

Hauptschalter-Not-Aus, Bodenmontage mit Stecktürkupplung für Zentralbefestigung Ø22mm  
Einbautiefe nicht einstellbar, Maß X bei Bestellung angeben IP66, cUL<sub>us</sub> Type 4X

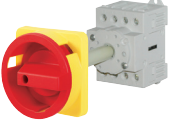
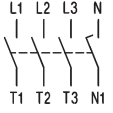
<b>4-polig, Sperrvorrichtung SV4</b>  							
		20A	<b>7,5kW</b>	64 □	LTS20 VZHN4 A4 X..	1	0,18
		25A	<b>10kW</b>	64 □	LTS25 VZHN4 A4 X..	1	0,18
		32A	<b>12,5kW</b>	64 □	LTS32 VZHN4 A4 X..	1	0,18
		40A	<b>16kW</b>	64 □	LTS40 VZHN4 A4 X..	1	0,18
		63A	<b>22kW</b>	64 □	LTS63 VZHN4 A4 X..	1	0,25
		80A	<b>22kW</b>	64 □	LTS80 VZHN4 A4 X..	1	0,25

Einbautiefe Maß X unbedingt angeben

<b>Typ</b>	<b>Vorzugswerte für X</b>
LTS.. VZHN..	80, 85, 104, 129 (Toleranz -3, +1,5)

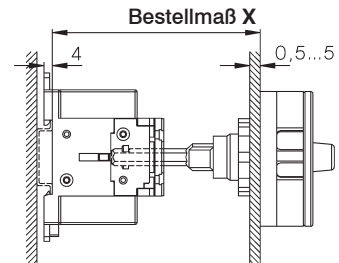





Zusatzmodule siehe Seite 297



1) Auf Anfrage auch in Schildgröße 88 □ erhältlich Typenzusatz **88** z. B: LTS32 VHN**488** A3

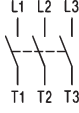

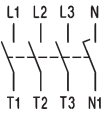

# Hauptschalter-Not-Aus, für Reiheneinbau, absperrrbar IP40, Open Type

	max. Schlösser	AC21 690V	AC23 3x400V	Schild	Typ	VPE Stk.	Gewicht kg/Stk.
<b>3-polig, Sperrvorrichtung SV1</b> 							
		20A	<b>7,5kW</b>	52x45	LTS20 SMAHN1 A3 <sup>2)</sup>	1	0,15
		25A	<b>10kW</b>	52x45	LTS25 SMAHN1 A3 <sup>2)</sup>	1	0,15
		32A	<b>12,5kW</b>	52x45	LTS32 SMAHN1 A3 <sup>2)</sup>	1	0,15
		40A	<b>16kW</b>	52x45	LTS40 SMAHN1 A3 <sup>2)</sup>	1	0,15
		63A	<b>22kW</b>	52x45	LTS63 SMAHN1 A3 <sup>2)</sup>	1	0,18
		80A	<b>22kW</b>	52x45	LTS80 SMAHN1 A3 <sup>2)</sup>	1	0,18
		85A	<b>30kW</b>	78x45	LTS85 SMAHN1 A3	1	0,37
100A	<b>37kW</b>	78x45	LTS100 SMAHN1 A3	1	0,37		
125A	<b>45kW</b>	78x45	LTS125 SMAHN1 A3	1	0,37		

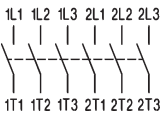
<b>4-polig, Sperrvorrichtung SV1</b> 							
		20A	<b>7,5kW</b>	52x45	LTS20 SMAHN1 A4 <sup>2)</sup>	1	0,16
		25A	<b>10kW</b>	52x45	LTS25 SMAHN1 A4 <sup>2)</sup>	1	0,16
		32A	<b>12,5kW</b>	52x45	LTS32 SMAHN1 A4 <sup>2)</sup>	1	0,16
		40A	<b>16kW</b>	52x45	LTS40 SMAHN1 A4 <sup>2)</sup>	1	0,16
		63A	<b>22kW</b>	52x45	LTS63 SMAHN1 A4 <sup>2)</sup>	1	0,21
		80A	<b>22kW</b>	52x45	LTS80 SMAHN1 A4 <sup>2)</sup>	1	0,21
		85A	<b>30kW</b>	78x45	LTS85 SMAHN1 A4	1	0,42
100A	<b>37kW</b>	78x45	LTS100 SMAHN1 A4	1	0,42		
125A	<b>45kW</b>	78x45	LTS125 SMAHN1 A4	1	0,42		

<b>6-polig, Sperrvorrichtung SV1(64)</b> 							
		20A	<b>7,5kW</b>	52x45	LTS20 SMAHN1 A6	1	0,29
		25A	<b>10kW</b>	52x45	LTS25 SMAHN1 A6	1	0,29
		32A	<b>12,5kW</b>	52x45	LTS32 SMAHN1 A6	1	0,29
		40A	<b>16kW</b>	52x45	LTS40 SMAHN1 A6	1	0,29
		63A	<b>22kW</b>	97x45	LTS63 SMAHN1 A6 <sup>1)</sup>	1	0,34
		80A	<b>22kW</b>	97x45	LTS80 SMAHN1 A6 <sup>1)</sup>	1	0,34

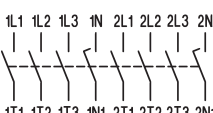
<b>8-polig, Sperrvorrichtung SV164</b> 							
		20A	<b>7,5kW</b>	97x45	LTS20 SMAHN1 A8	1	0,31
		25A	<b>10kW</b>	97x45	LTS25 SMAHN1 A8	1	0,31
		32A	<b>12,5kW</b>	97x45	LTS32 SMAHN1 A8	1	0,31
		40A	<b>16kW</b>	97x45	LTS40 SMAHN1 A8	1	0,31
		63A	<b>22kW</b>	126x45	LTS63 SMAHN1 A8	1	0,42
80A	<b>22kW</b>	126x45	LTS80 SMAHN1 A8	1	0,42		

## Umschalter mit Sperrvorrichtung für Reiheneinbau, absperrrbar

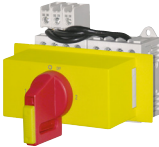
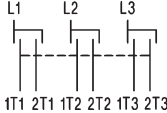
<b>3-polig, Sperrvorrichtung SV164</b> 							
		20A	<b>7,5kW</b>	97x45	LTS20 SMAHN1 U3	1	0,29
		25A	<b>10kW</b>	97x45	LTS25 SMAHN1 U3	1	0,29
		32A	<b>12,5kW</b>	97x45	LTS32 SMAHN1 U3	1	0,29
		40A	<b>16kW</b>	97x45	LTS40 SMAHN1 U3	1	0,29
		63A	<b>22kW</b>	97x45	LTS63 SMAHN1 U3	1	0,34

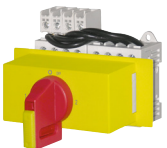
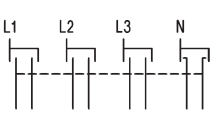
<b>4-polig, Sperrvorrichtung SV164</b> 							
		20A	<b>7,5kW</b>	97x45	LTS20 SMAHN1 U4	1	0,31
		25A	<b>10kW</b>	97x45	LTS25 SMAHN1 U4	1	0,31
		32A	<b>12,5kW</b>	97x45	LTS32 SMAHN1 U4	1	0,31
		40A	<b>16kW</b>	97x45	LTS40 SMAHN1 U4	1	0,31
		63A	<b>22kW</b>	126x45	LTS63 SMAHN1 U4	1	0,42













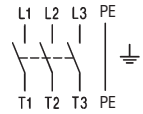



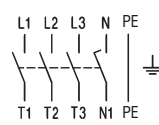



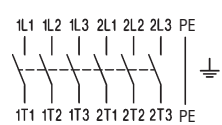

1) mit Sperrvorrichtung SV164

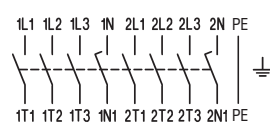
2) Hauptschalter-Not-Aus, für Reiheneinbau, absperrrbar mit **niedrigem Griff**, IP40

Typ mit Typenzusatz „+SV1N“ z.B.: **LTS40 SMAHN1 A3 +SV1N**

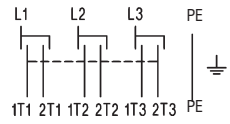



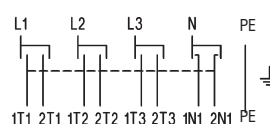





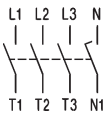

# Reparaturschalter-Not-Aus isolierstoffgekapselt, absperrbar IP66, cUL<sub>us</sub> Type 4X

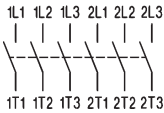

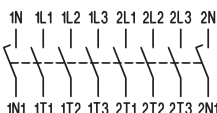
	max. Schösser	AC21 690V	AC23 3x400V	Schild	Typ	VPE Stk.	Gewicht kg/Stk.	
<b>3-polig, Sperrvorrichtung SV4(34)</b>  								
 		20A	<b>7,5kW</b>	64 □	LTS20 PF(L <sup>1</sup> )HN4 A3	1	0,32	
		25A	<b>10kW</b>	64 □	LTS25 PF(L <sup>1</sup> )HN4 A3	1	0,32	
		32A	<b>12,5kW</b>	64 □	LTS32 PF(L <sup>1</sup> )HN4 A3	1	0,32	
		40A	<b>16kW</b>	64 □	LTS40 PF(L <sup>1</sup> )HN4 A3	1	0,32	
		63A	<b>22kW</b>	64 □	LTS63 PFLHN4 A3	1	0,60	
		80A	<b>22kW</b>	64 □	LTS80 PFLHN4 A3	1	0,60	
		85A	<b>30kW</b>	64 □	LTS85 PFLHN4 A3	1	0,78	
		100A	<b>37kW</b>	64 □	LTS100 PFLHN4 A3	1	0,78	
		125A	<b>45kW</b>	64 □	LTS125 PFLHN4 A3	1	0,78	
		160A	<b>55kW</b>	88 □	LT160 PFHN34 T300	1	2,09	
Größeres Gehäuse Typ: ..PFL..	auf Anfrage							
<b>4-polig, Sperrvorrichtung SV4(34)</b>  								
 		20A	<b>7,5kW</b>	64 □	LTS20 PF(L <sup>1</sup> )HN4 A4	1	0,33	
		25A	<b>10kW</b>	64 □	LTS25 PF(L <sup>1</sup> )HN4 A4	1	0,33	
		32A	<b>12,5kW</b>	64 □	LTS32 PF(L <sup>1</sup> )HN4 A4	1	0,33	
		40A	<b>16kW</b>	64 □	LTS40 PF(L <sup>1</sup> )HN4 A4	1	0,33	
		63A	<b>22kW</b>	64 □	LTS63 PFLHN4 A4	1	0,64	
		80A	<b>22kW</b>	64 □	LTS80 PFLHN4 A4	1	0,64	
		85A	<b>30kW</b>	64 □	LTS85 PFLHN4 A4	1	0,83	
		100A	<b>37kW</b>	64 □	LTS100 PFLHN4 A4	1	0,83	
		125A	<b>45kW</b>	64 □	LTS125 PFLHN4 A4	1	0,83	
		160A	<b>55kW</b>	88 □	LT160 PFHN34 T400	1	2,47	
Größeres Gehäuse Typenzusatz +PF3 +PF3/M50	auf Anfrage auf Anfrage							
<b>6-polig, Sperrvorrichtung SV4</b>  								
 		20A	<b>7,5kW</b>	64 □	LTS20 PFLHN4 A6	1	1,39	
		25A	<b>10kW</b>	64 □	LTS25 PFLHN4 A6	1	1,39	
		32A	<b>12,5kW</b>	64 □	LTS32 PFLHN4 A6	1	1,39	
		40A	<b>16kW</b>	64 □	LTS40 PFLHN4 A6	1	1,39	
		63A	<b>22kW</b>	64 □	LTS63 PFLHN4 A6	1	1,42	
		80A	<b>22kW</b>	64 □	LTS80 PFLHN4 A6	1	1,42	
	Anbauerschraubung M50/40 +PF3/M50	auf Anfrage						
	<b>8-polig, Sperrvorrichtung SV4</b>  							
	 		20A	<b>7,5kW</b>	64 □	LTS20 PFLHN4 A8	1	1,44
			25A	<b>10kW</b>	64 □	LTS25 PFLHN4 A8	1	1,44
		32A	<b>12,5kW</b>	64 □	LTS32 PFLHN4 A8	1	1,44	
		40A	<b>16kW</b>	64 □	LTS40 PFLHN4 A8	1	1,44	
		63A	<b>22kW</b>	64 □	LTS63 PFLHN4 A8	1	1,50	
		80A	<b>22kW</b>	64 □	LTS80 PFLHN4 A8	1	1,50	
Anbauerschraubung M50/40 +PF3/M50		auf Anfrage						
<b>Umschalter mit Sperrvorrichtung, absperrbar</b>								
<b>3-polig, Sperrvorrichtung SV4</b>  								
 			20A	<b>7,5kW</b>	64 □	LTS20 PFLHN4 U3	1	1,39
		25A	<b>10kW</b>	64 □	LTS25 PFLHN4 U3	1	1,39	
		32A	<b>12,5kW</b>	64 □	LTS32 PFLHN4 U3	1	1,39	
		40A	<b>16kW</b>	64 □	LTS40 PFLHN4 U3	1	1,39	
		63A	<b>22kW</b>	64 □	LTS63 PFLHN4 U3	1	1,42	
<b>4-polig, Sperrvorrichtung SV4</b>  								
 		20A	<b>7,5kW</b>	64 □	LTS20 PFLHN4 U4	1	1,44	
		25A	<b>10kW</b>	64 □	LTS25 PFLHN4 U4	1	1,44	
		32A	<b>12,5kW</b>	64 □	LTS32 PFLHN4 U4	1	1,44	
		40A	<b>16kW</b>	64 □	LTS40 PFLHN4 U4	1	1,44	
		63A	<b>22kW</b>	64 □	LTS63 PFLHN4 U4	1	1,50	

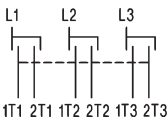
1) PFL..... größerer Anschlußraum

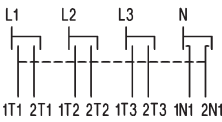

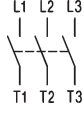

Lasttrennschalter für Einbau, IP66,  Type 3R

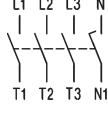
	AC21 690V	AC23 3x400V	Schild	Typ	VPE Stk.	Gewicht kg/Stk.
<b>Ein-Ausschalter 3-polig</b>						
 	20A	<b>7,5kW</b>	48 □	LTS20 E A3	1	0,15
	25A	<b>10kW</b>	48 □	LTS25 E A3	1	0,15
	32A	<b>12,5kW</b>	48 □	LTS32 E A3	1	0,15
	40A	<b>16kW</b>	48 □	LTS40 E A3	1	0,15
	63A	<b>22kW</b>	48 □	LTS63 E A3	1	0,17
	80A	<b>22kW</b>	48 □	LTS80 E A3	1	0,17
	85A	<b>30kW</b>	64 □	LTS85 E A3	1	0,39
	100A	<b>37kW</b>	64 □	LTS100 E A3	1	0,39
	125A	<b>45kW</b>	64 □	LTS125 E A3	1	0,39
	160A	<b>55kW</b>	88 □	LT160 E T300	1	1,10
<b>Ein-Ausschalter 4-polig</b>						
 	20A	<b>7,5kW</b>	48 □	LTS20 E A4	1	0,18
	25A	<b>10kW</b>	48 □	LTS25 E A4	1	0,18
	32A	<b>12,5kW</b>	48 □	LTS32 E A4	1	0,18
	40A	<b>16kW</b>	48 □	LTS40 E A4	1	0,18
	63A	<b>22kW</b>	48 □	LTS63 E A4	1	0,21
	80A	<b>22kW</b>	48 □	LTS80 E A4	1	0,21
	85A	<b>30kW</b>	64 □	LTS85 E A4	1	0,44
	100A	<b>37kW</b>	64 □	LTS100 E A4	1	0,44
	125A	<b>45kW</b>	64 □	LTS125 E A4	1	0,44
	160A	<b>55kW</b>	88 □	LT160 E T400	1	1,50
<b>Ein-Ausschalter 6-polig</b>						
 	20A	<b>7,5kW</b>	64 □	LTS20 E A6	1	0,30
	25A	<b>10kW</b>	64 □	LTS25 E A6	1	0,30
	32A	<b>12,5kW</b>	64 □	LTS32 E A6	1	0,30
	40A	<b>16kW</b>	64 □	LTS40 E A6	1	0,30
	63A	<b>22kW</b>	64 □	LTS63 E A6	1	0,36
	80A	<b>22kW</b>	64 □	LTS80 E A6	1	0,36
<b>Ein-Ausschalter 8-polig</b>						
 	20A	<b>7,5kW</b>	64 □	LTS20 E A8	1	0,32
	25A	<b>10kW</b>	64 □	LTS25 E A8	1	0,32
	32A	<b>12,5kW</b>	64 □	LTS32 E A8	1	0,32
	40A	<b>16kW</b>	64 □	LTS40 E A8	1	0,32
	63A	<b>22kW</b>	64 □	LTS63 E A8	1	0,43
	80A	<b>22kW</b>	64 □	LTS80 E A8	1	0,43
<b>Umschalter 3-polig</b>						
 	20A	<b>7,5kW</b>	64 □	LTS20 E U3	1	0,31
	25A	<b>10kW</b>	64 □	LTS25 E U3	1	0,31
	32A	<b>12,5kW</b>	64 □	LTS32 E U3	1	0,31
	40A	<b>16kW</b>	64 □	LTS40 E U3	1	0,31
	63A	<b>22kW</b>	64 □	LTS63 E U3	1	0,37
<b>Umschalter 4-polig</b>						
 	20A	<b>7,5kW</b>	64 □	LTS20 E U4	1	0,33
	25A	<b>10kW</b>	64 □	LTS25 E U4	1	0,33
	32A	<b>12,5kW</b>	64 □	LTS32 E U4	1	0,33
	40A	<b>16kW</b>	64 □	LTS40 E U4	1	0,33
	63A	<b>22kW</b>	64 □	LTS63 E U4	1	0,44

Lasttrennschalter für Zentralbefestigung, absperrbar IP66,  Type 4X

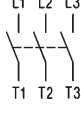
		max. Schlösser	AC21 690V	AC23 3x400V	Schild	Typ	VPE Stk.	Gewicht kg/Stk.
<b>Ein-Ausschalter 3-polig</b>								
 			20A	<b>7,5kW</b>	48 □	LTS20 Z A3	1	0,16
			25A	<b>10kW</b>	48 □	LTS25 Z A3	1	0,16
			32A	<b>12,5kW</b>	48 □	LTS32 Z A3	1	0,16
			40A	<b>16kW</b>	48 □	LTS40 Z A3	1	0,16
<b>Ein-Ausschalter 4-polig</b>								
 			20A	<b>7,5kW</b>	48 □	LTS20 Z A4	1	0,20
			25A	<b>10kW</b>	48 □	LTS25 Z A4	1	0,20
			32A	<b>12,5kW</b>	48 □	LTS32 Z A4	1	0,20
			40A	<b>16kW</b>	48 □	LTS40 Z A4	1	0,20

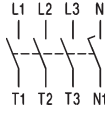
Lasttrennschalter, Bodenmontage mit Türkupplung für Zentralbefestigung Ø22mm  
Einbautiefe nachträglich einstellbar (Lieferlänge, X<sub>max</sub> siehe Seite 294) IP66,  Type 4X

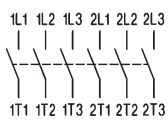
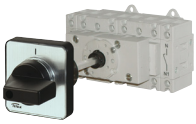
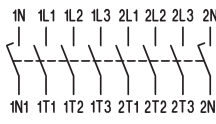
		max. Schlösser	AC21 690V	AC23 3x400V	Schild	Typ	VPE Stk.	Gewicht kg/Stk.
<b>Ein-Ausschalter 3-polig</b>								
 			20A	<b>7,5kW</b>	64 □	LTS20 VZV A3	1	0,19
			25A	<b>10kW</b>	64 □	LTS25 VZV A3	1	0,19
			32A	<b>12,5kW</b>	64 □	LTS32 VZV A3	1	0,19
			40A	<b>16kW</b>	64 □	LTS40 VZV A3	1	0,19
			63A	<b>22kW</b>	64 □	LTS63 VZV A3	1	0,22
			80A	<b>22kW</b>	64 □	LTS80 VZV A3	1	0,22
			85A	<b>30kW</b>	64 □	LTS85 VZV A3	1	0,40
			100A	<b>37kW</b>	64 □	LTS100 VZV A3	1	0,40
			125A	<b>45kW</b>	64 □	LTS125 VZV A3	1	0,40
<b>Ein-Ausschalter 4-polig</b>								
 			20A	<b>7,5kW</b>	64 □	LTS20 VZV A4	1	0,20
			25A	<b>10kW</b>	64 □	LTS25 VZV A4	1	0,20
			32A	<b>12,5kW</b>	64 □	LTS32 VZV A4	1	0,20
			40A	<b>16kW</b>	64 □	LTS40 VZV A4	1	0,20
			63A	<b>22kW</b>	64 □	LTS63 VZV A4	1	0,26
			80A	<b>22kW</b>	64 □	LTS80 VZV A4	1	0,26
			85A	<b>30kW</b>	64 □	LTS85 VZV A4	1	0,45
			100A	<b>37kW</b>	64 □	LTS100 VZV A4	1	0,45
			125A	<b>45kW</b>	64 □	LTS125 VZV A4	1	0,45
<b>Ein-Ausschalter 6-polig</b>								
 			20A	<b>7,5kW</b>	64 □	LTS20 VZV A6	1	0,32
			25A	<b>10kW</b>	64 □	LTS25 VZV A6	1	0,32
			32A	<b>12,5kW</b>	64 □	LTS32 VZV A6	1	0,32
			40A	<b>16kW</b>	64 □	LTS40 VZV A6	1	0,32
			63A	<b>22kW</b>	64 □	LTS63 VZV A6	1	0,37
			80A	<b>22kW</b>	64 □	LTS80 VZV A6	1	0,37
<b>Ein-Ausschalter 8-polig</b>								
 			20A	<b>7,5kW</b>	64 □	LTS20 VZV A8	1	0,34
			25A	<b>10kW</b>	64 □	LTS25 VZV A8	1	0,34
			32A	<b>12,5kW</b>	64 □	LTS32 VZV A8	1	0,34
			40A	<b>16kW</b>	64 □	LTS40 VZV A8	1	0,34
			63A	<b>22kW</b>	64 □	LTS63 VZV A8	1	0,45
			80A	<b>22kW</b>	64 □	LTS80 VZV A8	1	0,45

Lasttrennschalter, Bodenmontage mit Türkupplung für Zentralbefestigung Ø22mm  
 Einbautiefe nachträglich einstellbar (Lieferlänge,  $X_{max}$  siehe unten) IP66,  $c_{UL}$  us Type 4X

**Einbautiefe**  
**Zentralbefestigung Ø22mm**  
**LTS.. VZV..**

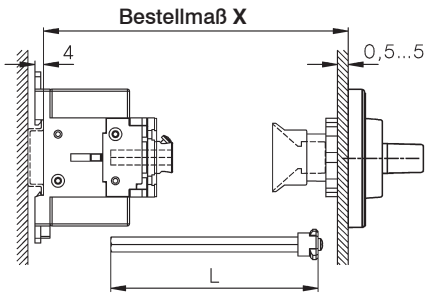

Typ		X min	X max	L
LTS20-80 VZV..	3, 4-polig	91 -	190	<b>X - 40±3</b>
LTS20-80 VZV..	6, 8-polig	111 -	190	<b>X - 60±3</b>
LTS85-125 VZV..	3, 4-polig	95 -	190	<b>X - 44±3</b>

**4-Lochbefestigung**  
**LTS.. V.. (3, 4-polig)**

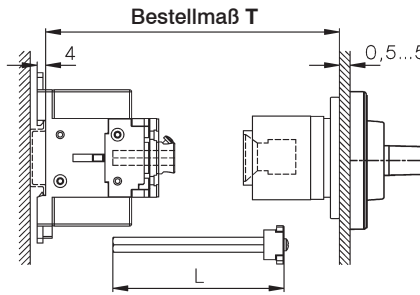

Typ		T min	T max	L	Typ	T min	T max
LTS20-80 V..		111 -	190	<b>T - 60±3</b>	LT160 V..	120 -	450
LTS85-125 V..		115 -	190	<b>T - 64±3</b>			

größere X- und T-Maße (max. 380mm für LTS..) auf Anfrage

Lasttrennschalter, Bodenmontage mit Türkupplung für 4-Lochbefestigung  
 Einbautiefe nachträglich einstellbar (Lieferlänge,  $T_{max}$  siehe oben) IP66,  $c_{UL}$  us Type 4X

	max. Schösser	AC21 690V	AC23 3x400V	Schild	Typ	VPE Stk.	Gewicht kg/Stk.
<b>Ein-Ausschalter 3-polig</b>							
	20A	<b>7,5kW</b>	64 □ <sup>1)</sup>	LTS20 V A3	1	0,20	
	25A	<b>10kW</b>	64 □ <sup>1)</sup>	LTS25 V A3	1	0,20	
	32A	<b>12,5kW</b>	64 □ <sup>1)</sup>	LTS32 V A3	1	0,20	
	40A	<b>16kW</b>	64 □ <sup>1)</sup>	LTS40 V A3	1	0,20	
	63A	<b>22kW</b>	64 □ <sup>1)</sup>	LTS63 V A3	1	0,24	
	80A	<b>22kW</b>	64 □ <sup>1)</sup>	LTS80 V A3	1	0,24	
	85A	<b>30kW</b>	64 □ <sup>1)</sup>	LTS85 V A3	1	0,40	
	100A	<b>37kW</b>	64 □ <sup>1)</sup>	LTS100 V A3	1	0,40	
	125A	<b>45kW</b>	64 □ <sup>1)</sup>	LTS125 V A3	1	0,40	
	160A	<b>55kW</b>	88 □	LT160 V T300	1	1,38	
<b>Ein-Ausschalter 4-polig</b>							
	20A	<b>7,5kW</b>	64 □ <sup>1)</sup>	LTS20 V A4	1	0,21	
	25A	<b>10kW</b>	64 □ <sup>1)</sup>	LTS25 V A4	1	0,21	
	32A	<b>12,5kW</b>	64 □ <sup>1)</sup>	LTS32 V A4	1	0,21	
	40A	<b>16kW</b>	64 □ <sup>1)</sup>	LTS40 V A4	1	0,21	
	63A	<b>22kW</b>	64 □ <sup>1)</sup>	LTS63 V A4	1	0,28	
	80A	<b>22kW</b>	64 □ <sup>1)</sup>	LTS80 V A4	1	0,28	
	85A	<b>30kW</b>	64 □ <sup>1)</sup>	LTS85 V A4	1	0,45	
	100A	<b>37kW</b>	64 □ <sup>1)</sup>	LTS100 V A4	1	0,45	
	125A	<b>45kW</b>	64 □ <sup>1)</sup>	LTS125 V A4	1	0,45	
	160A	<b>55kW</b>	88 □	LT160 V T400	1	1,77	

**Zusatzmodule** siehe Seite 297

1) Auf Anfrage auch in Schildgröße 88 □ erhältlich Typenzusatz **88** z. B: LTS32 VHN**488** A3

Lasttrennschalter, Bodenmontage mit Stecktürkupplung für Zentralbefestigung Ø22mm  
Einbautiefe nicht einstellbar, Maß X bei Bestellung angeben IP66,  $cULus$  Type 4X

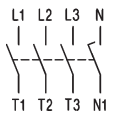
	max. Schösser	AC21 690V	AC23 3x400V	Schild	Typ	VPE Stk.	Gewicht kg/Stk.
<b>Ein-Ausschalter 4-polig</b>  	20A	7,5kW	64	□	LTS20 VZ A4 X..	1	0,18
	25A	10kW	64	□	LTS25 VZ A4 X..	1	0,18
	32A	12,5kW	64	□	LTS32 VZ A4 X..	1	0,18
	40A	16kW	64	□	LTS40 VZ A4 X..	1	0,18
	63A	22kW	64	□	LTS63 VZ A4 X..	1	0,25
	80A	22kW	64	□	LTS80 VZ A4 X..	1	0,25

Einbautiefe Maß X unbedingt angeben

Typ Vorzugswerte für X  
LTS.. VZ.. 80, 85, 104, 129 (Toleranz -3, +1,5)

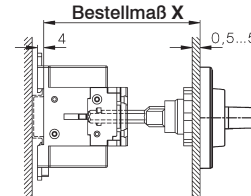

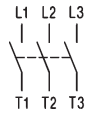

Zusatzmodule siehe Seite 297

Lasttrennschalter für Reiheneinbau IP40,  $cULus$  Open Type

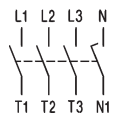
<b>Ein-Ausschalter 3-polig</b>  	20A	7,5kW	52x45	LTS20 SMA A3	1	0,15
	25A	10kW	52x45	LTS25 SMA A3	1	0,15
	32A	12,5kW	52x45	LTS32 SMA A3	1	0,15
	40A	16kW	52x45	LTS40 SMA A3	1	0,15
	63A	22kW	52x45	LTS63 SMA A3	1	0,17
	80A	22kW	52x45	LTS80 SMA A3	1	0,17

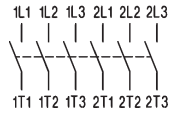
<b>Ein-Ausschalter 4-polig</b>  	20A	7,5kW	52x45	LTS20 SMA A4	1	0,16
	25A	10kW	52x45	LTS25 SMA A4	1	0,16
	32A	12,5kW	52x45	LTS32 SMA A4	1	0,16
	40A	16kW	52x45	LTS40 SMA A4	1	0,16
	63A	22kW	52x45	LTS63 SMA A4	1	0,21
	80A	22kW	52x45	LTS80 SMA A4	1	0,21

<b>Ein-Ausschalter 6-polig</b>  	20A	7,5kW	52x45	LTS20 SMA A6	1	0,29
	25A	10kW	52x45	LTS25 SMA A6	1	0,29
	32A	12,5kW	52x45	LTS32 SMA A6	1	0,29
	40A	16kW	52x45	LTS40 SMA A6	1	0,29
	63A	22kW	97x45	LTS63 SMA A6	1	0,34
	80A	22kW	97x45	LTS80 SMA A6	1	0,34

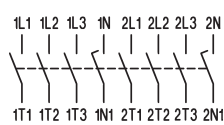

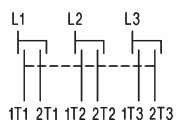

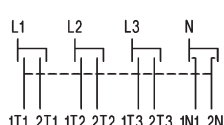



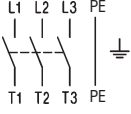

<b>Ein-Ausschalter 8-polig</b>  	20A	7,5kW	97x45	LTS20 SMA A8	1	0,31
	25A	10kW	97x45	LTS25 SMA A8	1	0,31
	32A	12,5kW	97x45	LTS32 SMA A8	1	0,31
	40A	16kW	97x45	LTS40 SMA A8	1	0,31
	63A	22kW	126x45	LTS63 SMA A8	1	0,42
	80A	22kW	126x45	LTS80 SMA A8	1	0,42

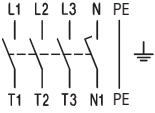
<b>Umschalter 3-polig</b>  	20A	7,5kW	97x45	LTS20 SMA U3	1	0,30
	25A	10kW	97x45	LTS25 SMA U3	1	0,30
	32A	12,5kW	97x45	LTS32 SMA U3	1	0,30
	40A	16kW	97x45	LTS40 SMA U3	1	0,30
	63A	22kW	97x45	LTS63 SMA U3	1	0,35

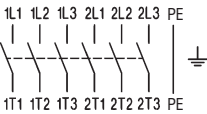
<b>Umschalter 4-polig</b>  	20A	7,5kW	97x45	LTS20 SMA U4	1	0,32
	25A	10kW	97x45	LTS25 SMA U4	1	0,32
	32A	12,5kW	97x45	LTS32 SMA U4	1	0,32
	40A	16kW	97x45	LTS40 SMA U4	1	0,32
	63A	22kW	126x45	LTS63 SMA U4	1	0,43

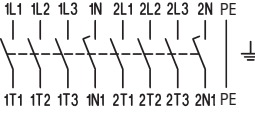

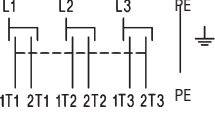

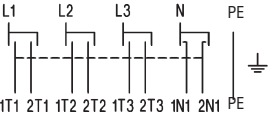











Lasttrennschalter isolierstoffgekapselt IP66, c(UL)us Type 4X

	AC21 690V	AC23 3x400V	Schild	Typ	VPE Stk.	Gewicht kg/Stk.	
<b>Ein-Ausschalter 3-polig</b>							
 	20A	<b>7,5kW</b>	64 □	LTS20 PF(L <sup>1)</sup> ) A3	1	0,30	
	25A	<b>10kW</b>	64 □	LTS25 PF(L <sup>1)</sup> ) A3	1	0,30	
	32A	<b>12,5kW</b>	64 □	LTS32 PF(L <sup>1)</sup> ) A3	1	0,30	
	40A	<b>16kW</b>	64 □	LTS40 PF(L <sup>1)</sup> ) A3	1	0,30	
	63A	<b>22kW</b>	64 □	LTS63 PFL A3	1	0,58	
	80A	<b>22kW</b>	64 □	LTS80 PFL A3	1	0,58	
	<b>Ein-Ausschalter 4-polig</b>						
 	20A	<b>7,5kW</b>	64 □	LTS20 PF(L <sup>1)</sup> ) A4	1	0,31	
	25A	<b>10kW</b>	64 □	LTS25 PF(L <sup>1)</sup> ) A4	1	0,31	
	32A	<b>12,5kW</b>	64 □	LTS32 PF(L <sup>1)</sup> ) A4	1	0,31	
	40A	<b>16kW</b>	64 □	LTS40 PF(L <sup>1)</sup> ) A4	1	0,31	
	63A	<b>22kW</b>	64 □	LTS63 PFL A4	1	0,62	
	80A	<b>22kW</b>	64 □	LTS80 PFL A4	1	0,62	
	<b>Ein-Ausschalter 6-polig</b>						
 	20A	<b>7,5kW</b>	64 □	LTS20 PFL A6	1	1,39	
	25A	<b>10kW</b>	64 □	LTS25 PFL A6	1	1,39	
	32A	<b>12,5kW</b>	64 □	LTS32 PFL A6	1	1,39	
	40A	<b>16kW</b>	64 □	LTS40 PFL A6	1	1,39	
	63A	<b>22kW</b>	64 □	LTS63 PFL A6	1	1,42	
	80A	<b>22kW</b>	64 □	LTS80 PFL A6	1	1,42	
	Anbauerschraubung M50/40 +PF3/M50 auf Anfrage						
<b>Ein-Ausschalter 8-polig</b>							
 	20A	<b>7,5kW</b>	64 □	LTS20 PFL A8	1	1,44	
	25A	<b>10kW</b>	64 □	LTS25 PFL A8	1	1,44	
	32A	<b>12,5kW</b>	64 □	LTS32 PFL A8	1	1,44	
	40A	<b>16kW</b>	64 □	LTS40 PFL A8	1	1,44	
	63A	<b>22kW</b>	64 □	LTS63 PFL A8	1	1,50	
	80A	<b>22kW</b>	64 □	LTS80 PFL A8	1	1,50	
	Anbauerschraubung M50/40 +PF3/M50 auf Anfrage						
<b>Umschalter 3-polig</b>							
 	20A	<b>7,5kW</b>	64 □	LTS20 PFL U3	1	1,39	
	25A	<b>10kW</b>	64 □	LTS25 PFL U3	1	1,39	
	32A	<b>12,5kW</b>	64 □	LTS32 PFL U3	1	1,39	
	40A	<b>16kW</b>	64 □	LTS40 PFL U3	1	1,39	
	63A	<b>22kW</b>	64 □	LTS63 PFL U3	1	1,42	
	<b>Umschalter 4-polig</b>						
	 	20A	<b>7,5kW</b>	64 □	LTS20 PFL U4	1	1,44
25A		<b>10kW</b>	64 □	LTS25 PFL U4	1	1,44	
32A		<b>12,5kW</b>	64 □	LTS32 PFL U4	1	1,44	
40A		<b>16kW</b>	64 □	LTS40 PFL U4	1	1,44	
63A		<b>22kW</b>	64 □	LTS63 PFL U4	1	1,50	

1) PFL.... größerer Anschlußraum













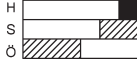

## Zusatzmodule zum Anbau an Hauptschalter für Einbau und Zentralbefestigung

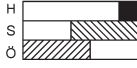
	für Schalter	Typ	VPE Stk.	Gewicht kg/Stk.	
	<b>4.Pol</b> für 3-polige Hauptschalter				
		LTS20 ... bis LTS40 ... LTS63 ... , LTS80 ...	N40E N80E	1 1	0,035 0,042
	<b>Hilfskontaktblock 1S + 1Ö</b>				
		LTS20 ... bis LTS125 ...	LH11	1	0,02
	<b>Hilfskontaktblock 1S + 1Ö überlappend</b>				
		LTS20 ... bis LTS125 ...	LH11X	1	0,02
	<b>Hilfskontaktblock 2Ö</b>				
		LTS20 ... bis LTS125 ...	LH20V/02E	1	0,02
	<b>PE-Klemme</b>				
		LTS20 ... bis LTS80 ... LT125 E.. bis LT160 E..	PE80E LTXX-E/E	1 1	0,04 0,2
	<b>N-Klemme</b>				
		LTS20 ... bis LTS80 ... LT125 E.. bis LT160 E..	PEN80E LTXX-N/E	1 1	0,04 0,2
	<b>Klemmenabdeckung 3-polig</b>				
		LTS20 ... bis LTS80 ... LTS85.. bis LTS125. LT125.. bis LT160..	KLAD70 KLAD125 XX-KLAD3	1 1 1	0,005 0,01 0,02
	<b>Netzseitige Klemmenabdeckung für 4. Pol</b>				
	Netzseitig Verbraucherseitig	LTS20 ... bis LTS80.. LTS20 ... bis LTS80..	KLAD70N KLAD70NI	1 1	0,002 0,002
	<b>Klemmenabdeckung 4-polig</b>				
		LTS85.. bis LTS125. LT125.. bis LT160..	KLAD125 XX-KLAD4	1 1	0,01 0,02

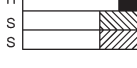
## Zubehör zum Anbau an Hauptschalter für Einbau, Zentralbefestigung und Bodenmontage

	für Schalter	Typ	VPE Stk.	Gewicht kg/Stk.
	<b>Zusatzschild gelb</b> mit Aufschrift: HAUPTSCHALTER			
	für Schild 48 <sup>r</sup> für Schild 64 <sup>r</sup>	LTS.. .HN1.. LTS.. .HN4..	A91501 E91501	1 1
	<b>Zusatzschild gelb</b> mit Aufschrift: MAIN SWITCH			
	für Schild 48 <sup>r</sup> für Schild 64 <sup>r</sup>	LTS.. .HN1.. LTS.. .HN4..	A91524 E91524	1 1
	<b>Flachsteckzunge 6,3 x 0,8mm</b> für nachträglichen Anbau			
		LTS20 ... bis LTS40 ...	LG11073	10

## Zusatzmodule zum Anbau an Hauptschalter für Bodenmontage und Reiheneinbau

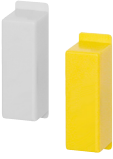
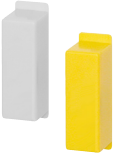
		für Schalter	Typ	VPE Stk.	Gewicht kg/Stk.	
	<b>4.Pol für 3-polige Hauptschalter</b>					
		LTS20 ... , LTS40 ... LTS63 ... , LTS80 ...	N40V N80V	1 1	0,035 0,042	
	<b>Hilfskontaktblock 1S + 1Ö</b>					
		LTS20 ... bis LTS125 ...	LH11	1	0,02	
	<b>Hilfskontaktblock 1S + 1Ö überlappend</b>					
		LTS20 ... bis LTS125 ...	LH11X	1	0,02	
	<b>Hilfskontaktblock 2S</b>					
		LTS20 ... bis LTS80 ...	LH20V/02E	1	0,02	
	<b>PE-Klemme</b>					
		LTS20 ... bis LTS80 ... LT125 .. bis LT160 ..	PE80V LTXX-E/V	1 1	0,04 0,2	
	<b>N-Klemme</b>					
		LTS20 ... bis LTS80 ... LT125 .. bis LT160 ..	PEN80V LTXX-N/V	1 1	0,04 0,2	
	<b>Klemmenabdeckung 3-polig</b>					
		LTS20 ... bis LTS40 ...	KLAD40	1	0,005	
		LTS63 ... bis LTS80 ...	KLAD70	1	0,005	
		LTS85.. bis LTS125.	KLAD125	1	0,01	
		LT125.. bis LT160..	XX-KLAD3	1	0,02	
	<b>Netzseitige Klemmenabdeckung für 4. Pol</b>					
	Netzseitig Verbraucherseitig	LTS63.., LTS80.. LTS63.., LTS80..	KLAD70N KLAD70NI	1 1	0,002 0,002	
	<b>Klemmenabdeckung 4-polig</b>					
		LTS20 ... bis LTS40 ...	KLAD40	1	0,005	
		LTS85.. bis LTS125.	KLAD125	1	0,01	
		LT125.. bis LT160..	XX-KLAD4	1	0,02	
	<b>Zusatzabdeckung SMA für</b>					
	4. Pol	N40V, N80V	grau	LG8628-2	1	0,047
	Hilfskontakt PE und N-Klemme	LH.. PE80V, PEN80V	gelb	LG8628-7	1	0,047

# Technische Daten

Daten nach IEC 947-3, IEC 947-5-1, VDE 0660, EN 60947-3, EN 60947-5-1

Typ	LTS20	LTS25	LTS32	LTS40	LTS63	LTS80	LTS85	LTS100	LTS125	LT160	
<b>Hauptkontakte</b>											
Thermischer Bemessungsbetriebsstrom $I_{th}$ offen	A	20	25	32	40	63	80	85	100	125	160
Therm. Bemessungsbetriebsstrom $I_{the}$ gekapselt	A	20	25	32	40	63	80	85	100	110	160
Bemessungsisolationsspannung $U_i$ <sup>1)</sup>	V	690	690	690	690	690	690	1000 <sup>3)</sup>	1000 <sup>3)</sup>	1000 <sup>3)</sup>	1000 <sup>3)</sup>
Bemessungsbetriebsstrom $I_g$ AC21A	A	20	25	32	40	63	80	85	100	125	160
Bemessungsbetriebsstrom $I_g$ max. AC21A	V	690	690	690	690	690	690	1000	1000	1000	690
Einschaltvermögen $I_{eff}$ 3x380-440V	A	160	190	220	300	370	440	600	725	850	1050
Ausschaltvermögen 3x220-240V	A	160	180	200	250	330	380	480	580	680	900
3x380-440V	A	160	180	200	250	330	380	480	580	680	850
3x660-690V	A	80	110	140	170	190	220	250	330	420	340
Trennerbedingungen erfüllt bis	V	690	690	690	690	690	690	1000	1000	1000	1000
Motorschalter AC3 3x400V	A	12	16	23	30	37	37	45	60	72	85
Motorschalter AC3 3x220-240V	kW	3	4	5,5	7,5	11	11	15	18,5	22	30
für betriebsmäßiges Schalten 3x380-440V	kW	5,5	7,5	11	15	18,5	18,5	22	30	37	45
3x660-690V	kW	5,5	7,5	11	15	18,5	18,5	22	30	37	37
Hauptschalter AC23 3x400V	A	16	20	25	32	45	45	60	72	85	110
Motorschalter, AC23A, 3x220-240V	kW	4	5,5	7,5	9	15	15	18,5	22	30	30
Hauptschalter, AC23B 3x380-440V	kW	7,5	10	12,5	16	22	22	30	37	45	55
Reparaturschalter 3x660-690V	kW	5,5	7,5	11	15	18,5	18,5	22	30	37	37
Bedingter Bemessungskurzschlußstrom 400V	kA <sub>eff</sub>	10	10	10	10	10	10	10	10	5	30
Maximale Vorsicherung gL (gG) 400V	A	25	35	40	40	63	80	100	100	125	160
Bedingter Bemessungskurzschlußstrom 690V	kA <sub>eff</sub>	10	5	3	1	5	1,5	10	10	5	-
Maximale Vorsicherung gL (gG) 690V	A	20	25	32	40	63	80	85	100	125	-
Mechanische Lebensdauer x10 <sup>3</sup>		200	200	200	200	100	100	100	100	100	100
Bemessungskurzzeitstromfestigkeit (1s-Strom)	A	250	300	400	500	600	850	1000	1200	1500	3000
Verlustleistung pro Pol P/Pol [W]	E, Z	0,322	0,503	0,824	1,288	2,739	4,416	3,851	5,330	8,328	-
bei AC21 = $I_{th}$	V, SMA, PF	0,364	0,569	0,933	1,458	2,739	4,416	3,851	5,330	8,328	-
	R/Pol [mOhm]	E, Z	0,805	0,805	0,805	0,805	0,690	0,533	0,533	0,533	-
	V, SMA, PF	0,911	0,911	0,911	0,911	0,690	0,690	0,533	0,533	0,533	-
<b>Zulässige Umgebungstemperatur</b> Betrieb offen	-40°C bis +60°C (90°C) <sup>5)</sup>										
gekapselt	-40°C bis +40°C										
Lagerung	-50°C bis +90°C										
<b>Anschlußquerschnitte</b>	mm <sup>2</sup>	0,5 - 10			1 - 25 <sup>4)</sup>			4 - 50			max.95
ein- oder mehrdrähtig	AWG	20 - 8 (10)			16 - 3 (10)			10 - 00 (10)			max.3/0
feindrähtig	mm <sup>2</sup>	0,5 - 6			4 - 16 <sup>4)</sup>			10 - 35			max.70
	AWG	20 - 10			16 - 6			8 - 2			max.2/0
feindrähtig mit Aderendhülse	mm <sup>2</sup>	0,5 - 6			0,75 - 16 <sup>4)</sup>			6 - 35			max.50
	AWG	20 - 10			16 - 6			8 - 2			max.1/0
Klemmschraube		M3,5			M5			M6			M10
Anzugsdrehmoment	Nm	1,7 - 2,3			2,8 - 4			1,7 - 4,5			14
<b>Hilfskontakte</b>											
Bemessungsisolationsspannung $U_i$ <sup>1)</sup>	V	690			690			690			690
Thermischer Bemessungsbetriebsstrom $I_{th}$ , $I_{the}$	A	10			10			10			16
Schaltvermögen AC15 380-450V	A	2,5/1,5			2,5/1,5			2,5/1,5			6/4
DC13 60-110V	A	2/0,4			2/0,4			2/0,4			-
Bedingter Bemessungskurzschlußstrom	kA <sub>eff</sub>	3			3			3			3
Maximale Vorsicherung gL (gG)	A	10			10			10			16
<b>Anschlußquerschnitte</b>	mm <sup>2</sup>	0,75 - 2,5			0,75 - 2,5			0,75 - 2,5			max.4
ein- oder mehrdrähtig	AWG	14 - 12			14 - 12			14 - 12			max.12
feindrähtig (+ Aderendhülse)	mm <sup>2</sup>	0,75 - 2,5 (1,5)			0,75 - 2,5 (1,5)			0,75 - 2,5 (1,5)			max.2,5
	AWG	18 - 14			18 - 14			18 - 14			max.14
<b>Daten nach UL und cUL</b>											
Typ	LTS20	LTS25	LTS32	LTS40	LTS63	LTS80	LTS85	LTS100	LTS125	LT160	
Bemessungsbetriebsspannung	V	600	600	600	600	600	600	600	600	600	
Ampere-Rating "General use"	A	20	25	32	40	63	80	85	100	200	
DOL-Rating 3-phase 110-120V	HP	1	1,5	2	2	3	5	7,5	10	20	
220-240V	HP	3	5	5	5	10	10	20	25	40	
440-480V	HP	7,5	10	10	10	20	20	40	50	60	
550-600V	HP	10	10	15	15	25	25	50	60	60	
DOL-Rating 1-phase 110-120V	HP	1	1	1	1	2	2	3	5	7,5	
200-208V	HP	1	2	2	2	3	3	7,5	10	10	
220-240V	HP	2	2	3	3	5	5	10	15	15	
Fuse size (RK5) Manual Motor Controller	A	40	50	50	70	90	110	125	125	125	
5kA / 600V Motor Disconnect	A	40	50	50	50	70	70	125	125	125	
Tightening torque	Nm	1,7-2,3	1,7-2,3	1,7-2,3	1,7-2,3	2,8-4	2,8-4	1,7-4,5	1,7-4,5	1,7-4,5	
	lb.inch	15-20	15-20	15-20	15-20	24-35	24-35	15-40	15-40	15-40	

1) gilt für: Netze mit geerdetem Sternpunkt, Überspannungskategorie I bis III, Verschmutzungsgrad 3 (Norm-Industrie):  $U_{max} = 6kV$ .

2) Fuse RK1 / 10kA / 600V

3)  $U_{imp} = 8kV$

5) Stromreduktion entsprechend Anschlußkabel 4) LTS63..U. mehrdrähtig 16mm<sup>2</sup>, eindrähtig 10mm<sup>2</sup>

Maße in mm

**Hauptschalter, Lasttrennschalter LT(S)..**

**Einbau LT.. E(HN)..**

Ein-Aus-Schalter 3-polig, 4-polig

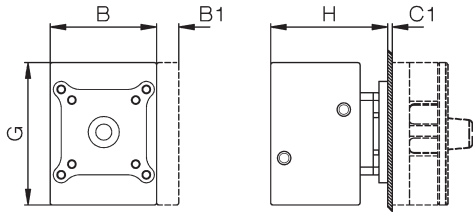

Ein-Aus-Schalter 6-polig, 8-polig  
Umschalter 3-polig, 4-polig

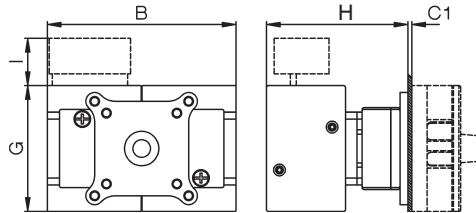

**Bohrplan**

Montageschraube: J3631N M=1,2-1,4 Nm

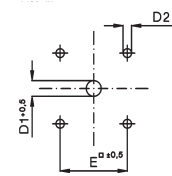

**Zentralbefestigung LTS.. Z(HN)..**

Ein-Aus-Schalter 3-polig, 4-polig

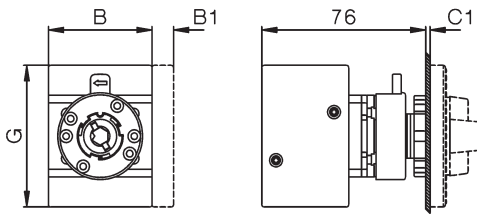

**Bohrplan**

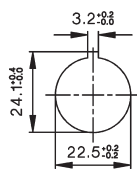

**Montage der Zusatzmodule LTS20 - LTS80**

Einbau, Zentralbefestigung

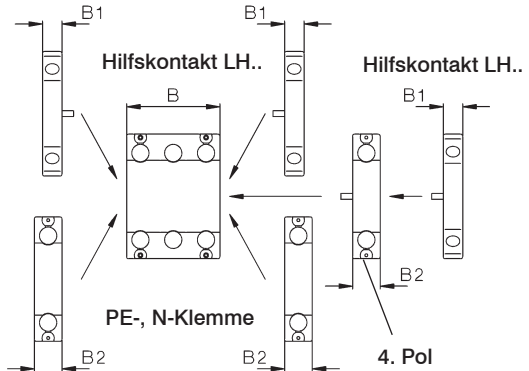

Typ	Schild	Sperrvorrichtung	Umschalter		3-polig		4-polig		Hilfskontakte	4.Pol PE				3,4-polig		3,4-polig		
			Ausschalter	3-polig	4-polig	6-polig	8-polig	B1		B2	C1	D1	D2	E	F	G	H	H
LTS20-80..	48 □, SV1		48	48	62,5	-	-	10	14,5	1-5	9	5	36	-	64	49	74	24
LTS20-80..	64 □, SV4, SV164		64	48	62,5	97	126	10	14,5	1-5	9	5	48	-	64	49	74	24
LTS85-125..	64 □, SV4		64	78	78	-	-	10	-	1-5	9	5	48	-	85	55	-	-
LTS85-125..	88 □, SV488		88	78	78	-	-	10	-	1-5	9	6	68	-	85	55	-	-
LT160	88 □, SV34		88	112	150	224	-	-	-	1-4	13-17	6	68	49,3	108	96	98	-

**Schild**

48 □

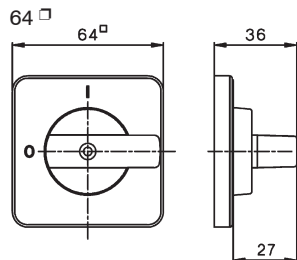
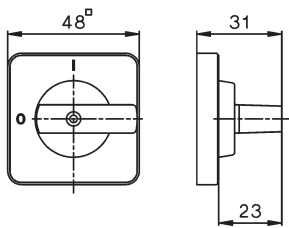

**Sperrvorrichtungen**

SV1

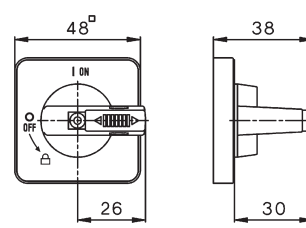

SV164

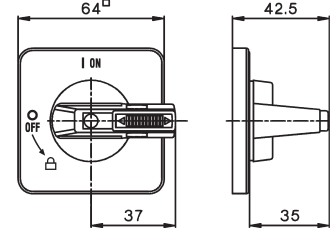

**Sperrvorrichtungen**

SV4

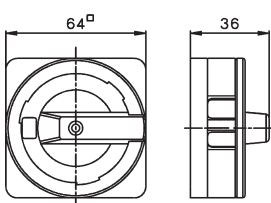

SV488

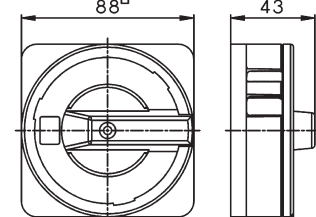

SV34

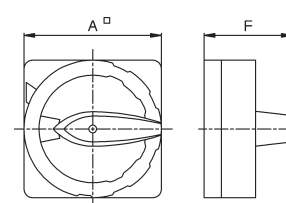

**Verlängerte Schalterwelle + VW"x"**

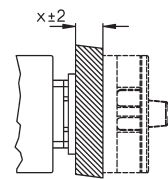

Maße in mm

**Hauptschalter, Lasttrennschalter LT(S)..**

**Bodenmontage LTS.. VZV(HN)..**

Ein-Aus-Schalter 3-polig, 4-polig

$L = X - 40 \pm 3$  für LTS20 - 80

$L = X - 44 \pm 3$  für LTS85 - 125

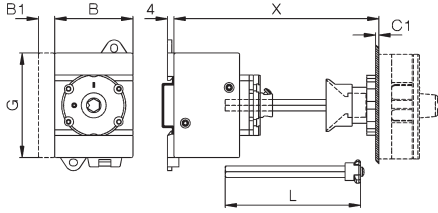

6-polig  
nur für LTS20 - 40  
 $L = X - 40 \pm 3$

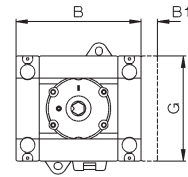

Ein-Aus-Schalter 6-polig, 8-polig  
Umschalter 3-polig, 4-polig  
 $L = X - 60 \pm 3$

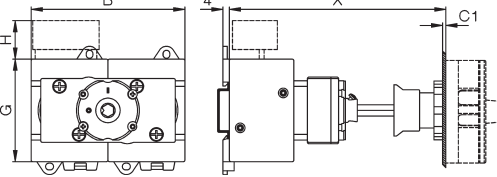

Bohrplan

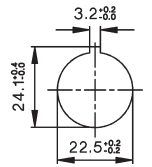

**Bodenmontage LT(S).. V(HN)..**

Ein-Aus-Schalter 3-polig, 4-polig

$L = T - 60 \pm 3$  für LTS20 - 80

$L = T - 64 \pm 3$  für LTS85 - 125

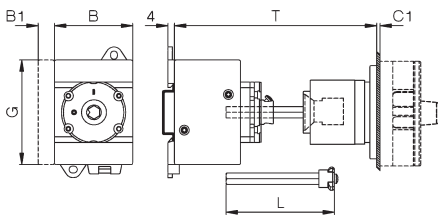

6-polig  
nur für LTS20 - 40  
 $L = T - 60 \pm 3$

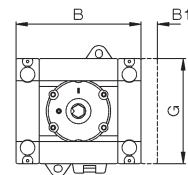

Ein-Aus-Schalter 6-polig, 8-polig  
Umschalter 3-polig, 4-polig  
 $L = T - 80 \pm 3$  gilt nur für Schalter LTS..

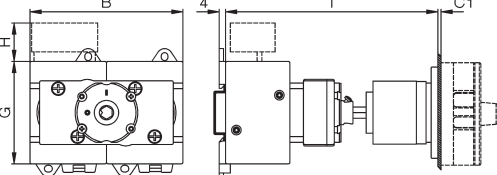

Bohrplan

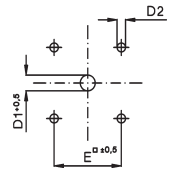

**Bodenmontage LTS.. VZ(HN)..**

Ein-Aus-Schalter 3-polig, 4-polig

Vorzugswerte für X: 80, 85, 104, 129

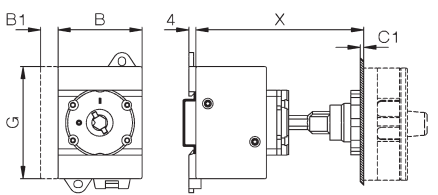

6-polig  
nur für LTS20 - 40

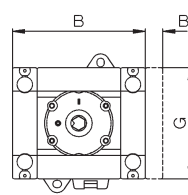

Ein-Aus-Schalter 6-polig, 8-polig  
Umschalter 3-polig, 4-polig

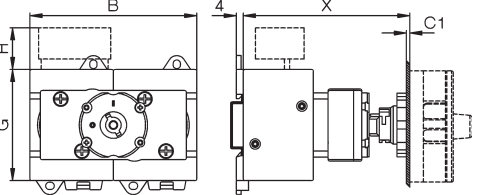

Bohrplan

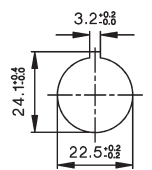

Typ	Umschalter Ausschalter Schild oder Sperrvorrichtung	3,4-polig					Hilfs- kontakte PE			C1	D1	D2	D3	E	G	K	K1	J
		3-polig	4-polig	6-polig	8-polig	4.Pol	B1	B2	H									
LTS20 -40	64 □, SV4, SV164	64	48	48	77	97	10	14,5	24	1-5	9	5	M4	48	64	25	48	70
LTS63, 80	64 □, SV4, SV164	64	48	62,5	97	126	10	14,5	24	1-5	9	5	M4	48	64	25	48	70
LTS85-125..	64 □, SV4	64	78	78	-	-	10	-	-	1-5	9	5	M4	48	85	38	-	90
LT125/160	88 □, SV34	88	112	150	224	-	-	-	-	1-4	13/27 <sup>2)</sup>	6	M6	68	108	36	-	120

**Bodenmontage**

Ein-Aus-Schalter LTS20 - LTS80

3-polig, 4-polig  
6-polig LTS20 -40

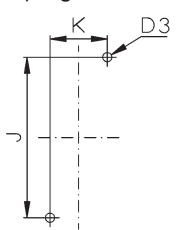

6-polig, 8-polig  
Umschalter

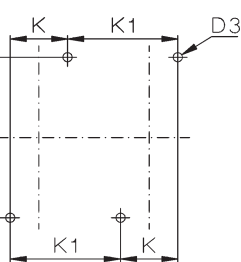

LTS85-125, LT160

3-polig, 4-polig

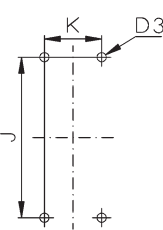

**Montage der Zusatzmodule LTS20 - LTS80**

Bodenmontage, Reiheneinbau

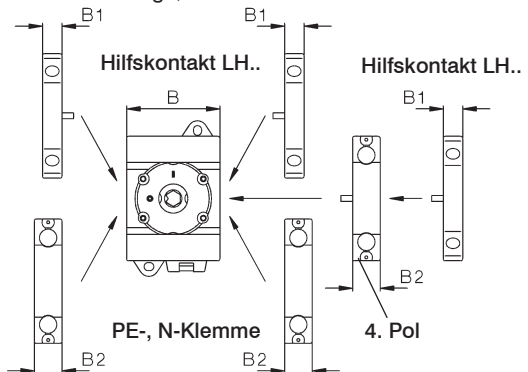

1) Ø 22-25 nur für LT80(100) VH(N)34 ..  
2) Ø 26-30 nur für LT125(160) VH(N)34 ..

Maße in mm

## Hauptschalter, Lasttrennschalter LT(S)..

### Reiheneinbau LT(S).. SMA(HN)..

Ein-Aus-Schalter 3-polig, 4-polig

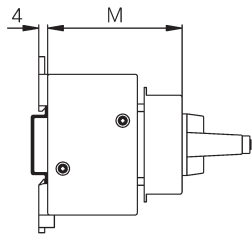
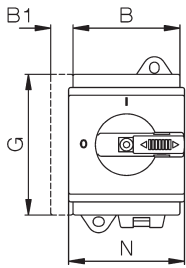

Ein-Aus-Schalter 6-polig  
nur für LTS20 - LTS40

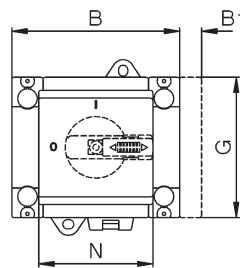

Ein-Aus-Schalter 6-polig, 8-polig  
Umschalter 3-polig, 4-polig

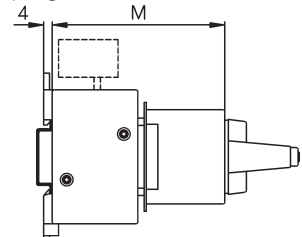
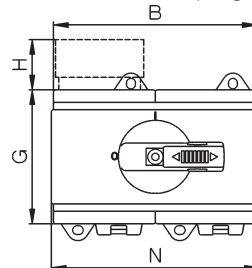

Typ	Sperrvorrichtung	Umschalter						G	3,4-polig			3,4-polig			H
		Ausschalter		3,4-polig		Hilfs- kontakte			3-polig		6-polig		8-polig		
		B	B	B	B	B1	B2	M	M	M	N	N	N		
LTS20 - 40	SV1, SV164	48	48	77	96	10	14,5	64	60	60	74	52	52	97 <sup>2)</sup>	24
LTS63, 80	SV1, SV164	48	62,5	96	125	10	14,5	64	60	79	79	52	97 <sup>2)</sup>	126 <sup>1)</sup>	-
LTS85-125..	SV164	78	78	-	-	10	-	85	60	-	-	78	-	-	-

### Reiheneinbau mit niedrigem Griff LTS SMAHN1.. +SV1N

Hauptschalter 3-polig, 4-polig LTS20 - LTS80

Sperrvorrichtung SV1

Sperrvorrichtung SV164

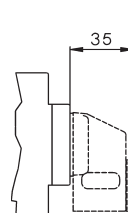
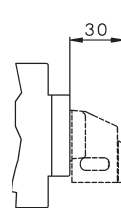
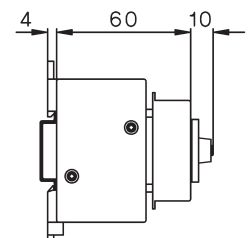
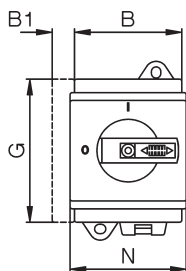

1) original Abdeckung

2) abbrechbare Laschen

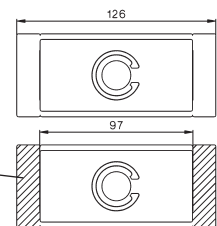

## Reparaturschalter isolierstoffgekapselt LT(S)..PF..

Typ	Pole	Größe	A	B	C	D1	D2	E	F	H
LTS20 PFH.. A. - LTS40 PFH.. A. <sup>3)</sup>	3, 4	PF1	130	98	120	2x25,5/20,5	-	75	100	76
LTS20 PFLH.. A., LTS40 PFLH A. <sup>3)</sup>	3, 4	PFL	180	98	170	2x25,5/20,5 / 16,5/12,5-	-	75	150	76
LTS20 PFLH.. A. - LTS40 PFLH.. A. <sup>4)</sup>	6	PFL2	200	140	188,5	40,5/32,5+16,5+12,5 -	-	100	160	86
LTS63 PFLH.. A. - LTS80 PFLH.. A. <sup>4)</sup>	3, 4	PFL2	200	140	188,5	40,5/32,5+16,5+12,5 -	-	100	160	86
LTS85 PFLH.. A. - LTS125 PFLH.. A. <sup>5)</sup>	3, 4	PFL2	200	140	188,5	40,5/32,5+16,5+12,5 -	-	100	160	86
Suffix + PF3	3, 4	PFL3	240	176	228,5	2x40,5/32,5	-	120	200	120
Suffix + PF3/M50	3, 4	PFL3	240	176	228,5	50,5/40,5	-	120	200	120
LTS20 PFLH.. A. - LTS40 PFLH.. A. <sup>5)</sup>	8	PFL3	240	176	228,5	2x40,5/32,5	-	120	200	120
LTS63 PFLH.. A. - LTS80 PFLH.. A. <sup>5)</sup>	6, 8	PFL3	240	176	228,5	2x40,5/32,5	-	120	200	120
Suffix + M50	6, 8	PFL3	240	176	228,5	50,5/40,5	-	120	200	120
LT160 PF..	3	PF4	300	200	-	2x50,5	25,5	172	272	172
LT160 PF..	4	PF5	300	280	-	2x50,5	-	254	254	180

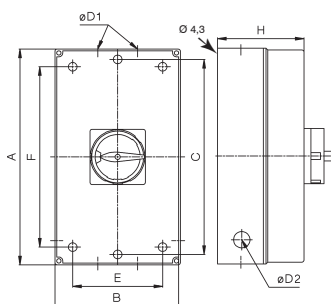

## Lasttrennschalter isolierstoffgekapselt LTS..PF..

Typ	Pole	Größe	A	B	C	D1	E	F	H
LTS20 PF A., LTS40 PF A. <sup>3)</sup>	3, 4	PF1	130	98	121	2x25,5/20,5	75	100	76
LTS20 PFL A., LTS40 PFL A. <sup>3)</sup>	3, 4	PFL	180	98	170	2x25,5/20,5 / 16,5/12,5	75	150	76
LTS63 PFL A., LTS80 PFL A. <sup>4)</sup>	3, 4	PFL2	200	140	188,5	40,5/32,5+16,5+12,5	100	160	86
Suffix + PF3	3, 4	PFL3	240	176	228,5	2x40,5/32,5	120	200	120
Suffix + PF3/M50	3, 4	PFL3	240	176	228,5	50,5/40,5	120	200	120

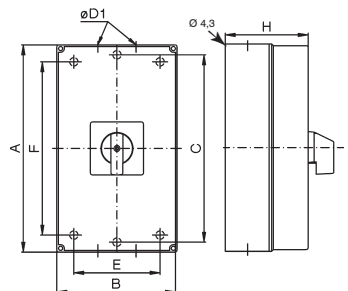

Maximale Bestückung in diesem Gehäuse:

3) LTS40 PF. A5 + LH11

4) LTS40 PFL.. A6, LTS80 PFL.. A5 + LH11, LTS125 PFL.. A4 + LH11

5) LTS40 PFL.. A10, LTS40 PFL.. U4 + LH11, LTS80 PFL.. A8, LTS80 PFL..; A6 + LH11, LTS40 PFL.. U3 + LH11; LTS125 PFL.. A4+LH11